



**WASCAL**  
West African Science Service Center on  
Climate Change and Adapted Land Use



## **UNIVERSITÉ ABDOU MOUMOUNI**

### **West African Science Service Centre on Climate Change and Adapted Land Use (WASCAL)**

#### **MASTER RESEARCH PROGRAM ON CLIMATE CHANGE AND ENERGY (MRP-CCE)**

---

*A thesis submitted in partial fulfillment for the degree  
of Master of Science in Climate Change and Energy*

---

Subject:

### ***TECHNICAL PERFORMANCES AND SOCIO-ECONOMIC IMPACTS OF MINI SOLAR SYSTEMS IN RURAL AREA (NIGER)***

---

Jury members:

*Prof. FALL Modou*

*Prof. Nanéma Emmanuel*

*Dr. Saleye Yahaya*

*Prof. Rabani Adamou, MC*

*Chairman*

*Examiner*

*Director*

*Co-Director*

---

Thesis Defense: 7<sup>th</sup> March 2018

Author:

**ABASS HAROU Hadiza**

1<sup>st</sup> Supervisor: Dr. Saleye Yahaya

2<sup>nd</sup> Supervisor: Dr. Rabani Adamou, MC

## QUOTATION

*« We need to invest dramatically in green energy, making solar panels so cheap that everybody wants them. Nobody wanted to buy a computer in 1950, but once they got cheap, everyone bought them. »*

Bjorn Lomborg

## DECLARATION

*I hereby declare that I am the sole author of this thesis. This is a true copy of the thesis, including any required final revisions, as accepted by my examiners.*

## DEDICATION

*In memory of my beloved brother Abass Harou Mohammed, may his soul rest in peace. To my kind and warm family: my father Abass Harou, my mother Asmaou Nafiou, my brother Abass Harou Nassirou, my sister Abass Harou Mariatou.*

## ACKNOWLEDGMENT

Thank God, the Almighty, the merciful who helped us achieve this modest work.

A special mention to my family, ABASS Harou family: Nasser, Marie, Dad, and Mum. Thank you too much for your both moral and financial support.

My deep and sincere thanks go to my main supervisor Dr. Saleye Yahaya for his worthy support that allows conducting all my experiments but also for his wise advice, criticism, and corrections throughout this work. May he find here, my deepest gratitude for not sparing any effort for the completion of this work. It was a real challenge as an environmentalist to have ventured into the field of electrical engineering, I appreciated, I learned and benefit a lot of. Thank you very much.

My thanks go also to CNES staff for their support.

My special thanks to my co-supervisor Dr. Rabani Adamou for sparing any effort for the success of my work but also for his availability and help in achieving this work.

I acknowledge with thanks the scholarship and financial support provided to me by BMBF, The Federal Ministry of Education and Research of Germany and the West African Science Service Centre on Climate Change and Adapted Land Use (WASCAL).

I would like to acknowledge the director of the program, Dr. Rabani ADAMOUE, the coordinator Maman Maarouhi and all the staff member of the MRP Climate Change and Energy for their support and implications in the successfulness of this program.

My sincere gratitude to all our lecturers for the time spent to teach us.

My acknowledgments to all those whose names could not be quoted, I wish to express my deep gratitude to them, I thank them for their trust and their precious help.

My big thanks to my former school EMIG (École des Mines de l'Industrie et de la Géologie) without forgetting my colleagues from the Ministry of Road especially those from Technical Study Direction for their support.

Special thanks to my two brothers PhD Thomas Yameogo and PhD Abdou Boko Aboubacar for their inestimable help. Thanks also to the WASCAL competence Center.

Last but not the least, I would like to thank all my classmates and Mr. David, Mr. Djibril too.

## ABSTRACT

Regarding the context of climate change mitigation and adaptation for a sustainable energy and energy efficiency, the use of renewable and clean energy becomes increasingly paramount. Thus, many solar energy rural programs are set up throughout the world. However, due to environmental and meteorological conditions, installed PV systems efficiency mostly depends on the geographical location. Therefore, technical performances of a mini PV platform in Sarando Bené village have been assessed with the design criteria for better performance needs. CR1000 data logger, pyranometer, flow and water meters, panel meters (V-meters, A-meters meters) have been used to measure solar radiation current and voltage in order to determine solar radiation, I-V curves, energy demand, efficiency, performance ratio (PR), etc. Temperature sensors have been used to assess respectively ambient and back panels' temperatures. While in order to evaluate PV systems impacts on rural population, social and economic data from field survey (qualitative and quantitative) and from Niger Institute of Statistic (INS) have also been collected and used.

The obtained results show that solar pump and electricity generator perform well in the rural area. However, the study reveals that a mixture of different and contrasted solar panels lead to high loss of efficiency (up to 28% and 64% respectively for the two types), as the panels functioning point is not the expected one. A bad battery wiring together with charge controller and inverter leads to an untimely worn out of the battery (less than 18 months versus the five expected years). A bad sizing of the solar pump in a relationship with the borehole depth also induces a low-performance ratio (up to 50%).

The second series of results is as surprising as the first one. It shows at what scale solar energy is currently used in Niger, almost without any meaningful support from the government. The result is that almost everybody uses solar energy system in the studied area, for education, health, lighting and other social and economic purposes. These results will, of course, help policymakers and stakeholders to enhance technical support as well as socioeconomic measures to boost solar self-electrification in rural and urban off-grid areas.

Keywords: technical performances, socioeconomic impacts, rural, PV systems, climate change.

---

## Contents

QUOTATION .....	ii
DECLARATION .....	iii
DEDICATION .....	iv
ACKNOWLEDGMENT .....	v
ABSTRACT.....	vi
LIST OF FIGURES .....	x
LIST OF TABLES .....	xii
LIST OF ABBREVIATIONS AND ACRONYMS .....	xiii
SYMBOLS.....	xiii
GENERAL INTRODUCTION .....	1
Chapter I: SOLAR ENERGY CONVERSION AND USE: CASE OF PHOTOVOLTAIC SYSTEM.....	5
Introduction .....	6
1.1. Solar Radiation.....	6
1.1.1. Sun Position in the Sky .....	6
1.1.2. Fundamentals of Solar Radiation .....	9
1.1.3. Solar Spectrum .....	9
1.1.4. Air Mass.....	11
1.1.5. Clearness Index .....	12
1.1.6. Solar Energy Measurement .....	13
1.1.7. Solar Radiation Models on Tilted Surfaces .....	13
1.2. Solar PV Design and Simulation Software .....	14
1.2.1. PVSyst Software .....	15
1.2.2. Homer for Grid and Off-Grid Power System.....	15
1.2.3. RETScreen Software .....	15
1.2.4. System Advisor Model (SAM) Software.....	15
1.3. PV System .....	16
1.3.1. Principle of a PV Effect .....	16
1.3.2. Description of a PV Cell .....	17
1.3.3. P-N Junction in Semi-Conductor.....	17
1.3.4. Notion of Photoconductivity .....	18
1.3.5. Conception of a Solid Crystallized PV Module .....	19
1.3.6. Electrical Characteristics .....	20
1.3.7. Photovoltaic Systems.....	23

1.3.8.	PV System Dimensioning .....	27
1.4.	Utilization of Solar PV in Niger: Inventory and Estimation.....	30
1.4.1.	Community and commercial utilization.....	31
1.4.2.	Personal utilization .....	33
	Partial Conclusion.....	35
Chapter II: TECHNICAL PERFORMANCES AND USE OF PHOTOVOLTAIC SYSTEM IN SCIENTIFIC LITERATURE		36
	Introduction .....	37
2.1.	Parameters Affecting Solar Panels Performances .....	37
2.1.1.	Effect of Dust .....	37
2.1.2.	Effect of Orientation and Tilted Angle on PV Panels.....	38
2.1.3.	Effect of Temperature PV Cell ( $T_{NOCT}$ ) .....	39
2.1.4.	Effect of Shading, Ambient Temperature, Irradiance, Wind Speed and Humidity on PV Cell Performance .....	40
2.2.	PV Energy Storage System Performances .....	42
2.3.	PV Pumping System Performances.....	42
2.4.	Use of PV system.....	43
2.4.1.	PV Market in Rural Areas.....	43
2.4.2.	Socioeconomics Impacts of Solar PV Energy Use.....	44
	Partial Conclusion.....	45
Chapter III: MATERIALS AND METHODS .....		46
	Introduction .....	47
3.1	Study Areas Presentation .....	47
3.1.1	Technical Performances Study Area .....	47
3.1.2	Socio-Economic Study Area.....	48
3.1.3	Meteorological Features of the Sites .....	49
3.2	Technical Characteristics of Study Installations.....	50
3.2.1	Solar Pump.....	50
3.2.2	Micro Domestic Generator (MDG).....	55
3.2.3	Measurement Sensors and Datalogger.....	60
3.2.4	Experiment Running.....	64
3.3	Socio-Economic Study Material and Method .....	65
3.3.1	Local Inquiry in a small size village Kobadjé.....	65
	Partial Conclusion.....	66
CHAPTER IV: RESULTS, ANALYSIS, AND INTERPRETATION.....		67



Introduction .....	68
4.1. Technical Performances Study .....	68
4.1.1. Solar Panel Performances .....	68
4.1.2. Pump Performances .....	78
4.1.3. Battery Performances .....	81
4.1.4. Inverter Performances .....	84
4.1.5. Charge Controller Performances .....	85
4.2. Socio-Economic Study .....	85
4.2.1. Households Surveys .....	85
4.2.2. Commercial Surveys .....	89
Partial Conclusion .....	92
<b>GENERAL CONCLUSION</b> .....	93
Completion .....	93
<b>BIBLIOGRAPHY</b> .....	95
<b>WEBOGRAPHY</b> .....	100
<b>APPENDIX</b> .....	102
Appendix A: Datalogger Connection Scheme .....	I
Appendix B: Datalogger Running Program .....	II
Appendix C: Technical Characteristics of Isöfoton Batteries .....	IV
Appendix D: Household's Inquiry .....	V
Appendix E: Commercial Inquiry .....	XI
Appendix F: Income Category According to the Source of Income .....	XV
Appendix G: Some Experimental Data .....	XVI

## LIST OF FIGURES

Figure 0-1: Solar PV Total Global Capacity, 2004-2013 (Source: REN21 Secretariat, 2012) .....	1
Figure 0-2: Africa Radiation Map (Source: NREL) .....	2
Figure 0-3: Niger PV Power Potential Map (Source: World Bank Group) .....	3
Figure 1-1: Surface-Sun angles (Source: J.A. Duffie and W.A. Beckman, 1980) .....	7
Figure 1-2: Sun's path in the sky (Source: New Energy Research) .....	8
Figure 1-3: Annual changes in sun's position in the sky (Source: Akram Abdulameer Abbood Al-Khazzar, 2015).....	8
Figure 1-4: Solar Spectrum Chart (Source: Short N.M. NASA remote sensing tutorial).....	10
Figure 1-5: Solar radiation spectrum regarding its wavelength (Source: Wikipedia, 2015).....	10
Figure 1-6: Various air mass and corresponding zenith angles in a plane parallel atmosphere (Source: Qasem, 2007).....	12
Figure 1-7: Solar Radiation Components (Source: Energy Professional Symposium).....	13
Figure 1-8: Solar cell P-N junctions (Modified from electrical4u.com, accessed on 21/04/2017). 16	
Figure 1-9: Structure of silicon crystalline. (Source: SERI, 1981) .....	19
Figure 1-10: Chain of Photovoltaic Technologies of silicon crystalline (Source: Dajuma, 2015) .20	
Figure 1-11: Ideal solar cell with a single diode (Source: Rodrigues et al., 2011).....	21
Figure 1-12: Ideal solar cell with a single diode and series resistance (Source: Rodrigues et al., 2011) .....	21
Figure 1-13: Cell, module, and array of solar PV (Source: Gary et al., 1995).....	24
Figure 1-14: Components of a PV system (Abdelkader et al., 2010) .....	24
Figure 1-15: Evolution of the capacity of photovoltaic installations (Source: CNES, 2016).....	31
Figure 1-16: Repartition of photovoltaic installed capacity per application (Source: CNES, 2016) .....	32
Figure 1-17: Repartition of photovoltaic installed capacity per region (Source: CNES, 2016) .....	32
Figure 1-18: PV market in Tillabéry, Niger (Source: CNES, 2016, data from 2014 inventory and estimation) .....	33
Figure 1-19: 2013 PV market in Niger (Source: RAACH SOLAR, estimations, empirical data)....	34
Figure 2-1: Climatic conditions: Annual curves of horizontal visibility and precipitation. (Source: After Frangi et al., 1992).....	38
Figure 2-2: Temperature effect on the PV characteristics (Gueymard, 2009) .....	40
Figure 2-3: Irradiance effect on the PV characteristics (Gueymard, 2009).....	41
Figure 2-4: PV pumping system performance curve (Source: A. Mokeddem et al., 2011) .....	43
Figure 3-1: Study area of PV installed .....	48
Figure 3-2: Study area with surveyed villages .....	49
Figure 3-3: Scheme of the solar pump installation .....	50
Figure 3-4: Photography of the pump and DMG panels, pyranometer, and ambient temperature shelter. ....	52
Figure 3-5: Abacus of the pump (power versus height and flow) .....	53
Figure 3-6: Abacus of the pump (flow versus height and power) .....	54
Figure 3-7: Scheme of the Micro Domestic Generator (MDG) .....	56
Figure 3-8: Photography of the charge controller connected .....	59
Figure 3-9: Photography of the inverter connected .....	60
Figure 3-10: CR1000 Datalogger, Campbell Scientific .....	63
Figure 3-11: Photography of CR1000 Datalogger .....	63
Figure 4-1: In field Isòfoton panel ratio (21/11/2017).....	70

Figure 4-2: Isòfoton and Sunshine Solar panel ratio while the pump running (19/12/2017).....	71
Figure 4-3: Variation of the two types panels voltage with solar radiation (19/12/2017).....	72
Figure 4-4: I-V characteristic curves of the two sets of panels and their addition.....	73
Figure 4-5: Variation of the current with the solar radiation (19/12/2017) .....	74
Figure 4-6: Variation of the relative power with the solar radiation (19/12/2017) .....	74
Figure 4-7: Solar cells' efficiency versus temperature for various materials (Source: SERI, 1981). .....	76
Figure 4-8: Differences between Ambient and Panels Walls Temperatures. ....	77
Figure 4-9: Temperature discards between the wall temperatures of the panels (Isòfoton and Sunshine Solar) and the ambient temperature versus solar radiation.....	78
Figure 4-10: Optimum solar power for a pumping height 30 m .....	79
Figure 4-11: Optimum solar power according to the pumping height.....	79
Figure 4-12: Measured and given (by manufacturer) efficiencies of the pump.....	80
Figure 4-13: Electrical characteristic of the pump, I-V curve.....	81
Figure 4-14: Variation of the battery voltage by night and daytime (10-11/11/2017).....	83
Figure 4-15: Variation of the battery voltage with solar radiation (10/11/2017) .....	84
Figure 4-16: Scheme of the effective connection of the system (Source: <a href="http://motorhomeadvantage.com/rv-solar/">http://motorhomeadvantage.com/rv-solar/</a> ) .....	84
Figure 4-17: Reasons for using Solar PV .....	87
Figure 4-18: Impacts perceptions.....	87
Figure 4-19: PV technologies impacts' perceptions .....	88
Figure 4-20: Reasons why persons will agree to invest in Solar PV systems .....	88
Figure 4-21: Surveyed villages repartition .....	89
Figure 4-22: Gender and Interviewee repartition .....	90
Figure 4-23: Year of PV Panels installation .....	90
Figure 4-24: Income sources of interviewees.....	91
Figure 4-25: Working period of PV systems during a day. ....	91
Figure 4-26: Turnover perception. ....	92

## LIST OF TABLES

<i>Table 1-1: General outline of main solar design and simulation software.</i> .....	14
<i>Table 1-2: Technical characteristics of PV Module types (Source: Brigand, 2011)</i> .....	25
<i>Table 1-3: Range of energy efficiency of inverters (Source: Fraunhofer ISE, 2014).</i> .....	27
<i>Table 1-4: Generator voltage in function of power (Source: Brigand, 2011)</i> .....	28
<i>Table 1-5: Solar radiation data of Niamey in 2015 (Source: CNES, 2015)</i> .....	30
<i>Table 2-1: Ambient Temperature Variation according to the PV technology (Source: A. A. Hossam-Eldin, C.F. Gabra and Ahmed Hamza H. Ali, 2014)</i> .....	41
<i>Table 3-1: Technical characteristics of the borehole</i> .....	51
<i>Table 3-2: Technical characteristics of the two PV Module types</i> .....	51
<i>Table 3-3: Technical specification of the pump</i> .....	53
<i>Table 3-4: Technical characteristics of the panel position</i> .....	55
<i>Table 3-5: Estimation of the daily energy demand</i> .....	57
<i>Table 3-6: Technical characteristics of the PV panel</i> .....	57
<i>Table 3-7: Technical characteristics of the batteries</i> .....	58
<i>Table 3-8: Technical characteristics of the charge controller</i> .....	58
<i>Table 3-9: Technical characteristics of the inverter</i> .....	59
<i>Table 3-10: Framework of the utilization of measurement sensors</i> .....	61
<i>Table 3-11: Technical characteristics of the pyranometer</i> .....	61
<i>Table 3-12: Specifications of the free pumping period</i> .....	64
<i>Table 3-13: Specifications of the controlled pumping period</i> .....	65
<i>Table 4-1: Characteristic constants of the two PV Module types (See Table 3-1)</i> .....	69
<i>Table 4-2: Voltage correlation between Isòfoton and Sunshine panels the pump running</i> .....	71
<i>Table 4-3: Characteristic constants of the PV Module types (See Table 6)</i> .....	75
<i>Table 4-4: Parameters required for the evaluation of crest installed power</i> .....	76
<i>Table 4-5: Parameters of the hydraulic efficiency in the range of 30 to 45 m height</i> .....	80
<i>Table 4-6: Pump impedance linear model constants</i> .....	81
<i>Table 4-7: Technical characteristics of the batteries (See Table 3-7 and Appendix C)</i> .....	82
<i>Table 4-8: Parameters required for the evaluation of the battery capacity</i> .....	82
<i>Table 4-9: Determination of the required inverter's power</i> .....	85
<i>Table 4-10: Determination of the required charge controller parameters</i> .....	85
<i>Table 4-11: Sources of financing, purchase, and installation of PV technologies</i> .....	86

## LIST OF ABBREVIATIONS AND ACRONYMS

AC	Alternative Current
AM	Atmospheric Mass
a-Si	Amorphous Silicon
c-Si	Crystalline Silicon
DC	Direct current
DNK	Don't know
DOD	Depth of Discharge
FF	Fill factor
GHE	Greenhouse effect.
GHG	Greenhouse Gas.
INS	Institut National de la Statistique
LED	Light emitting diodes
MDG	Micro Domestic Generator
MPPT	Maximum Power Point Tracking
M-Si	Monocrystalline Silicon
NG	Natural Gas
NGO	Non-Governmental Organization.
NIGELEC	la Nigérienne de l'Electricité.
p-Si	Polycrystalline Silicon
PPP	Public-Private Partnership.
PV	Photovoltaic.
ROHS	Restriction of Hazardous Substances (European Union Directive 2002/95/CE)
SAS	Stand-Alone PV System.
SHS	Solar Home System.
WMO	World Meteorology Organization.
Wp	Watt-peak

## SYMBOLS

### LATIN LETTERS

a	Constant of linearity
$A_0$	Non-ideality factor
b	Constant of linearity
$E_d$	Daily energy need
$E_g$	Band gap of the material
$E_r$	Daily solar radiation for the unfavorable month
G	Incident global irradiance
$H_e$	Number of equivalent hours
I	Current

$I_0$	Saturation current
$I_d$	Diode current.
$I_m$	Maximum output current
$I_S$	Photo generated current
$I_{sc}$	Short circuit current
$J_0$	Saturation current per surface area
$k$	Factor taking into account the current take-off at the starting of the appliances
$k_b$	Boltzmann constant, equal to $1.38 \cdot 10^{-23} \text{J/K}$
$N_{aut}$	Number of autonomy days of the batteries
$P_c$	crest installed power
$P_{ac}$	Receiver's power functioning in alternative current.
$P_i$	$i^{\text{th}}$ receiver's power
$P_{inv}$	Nominal inverter power
$P_p$	Panel power
$q$	Electron charge, equal to $1.602 \cdot 10^{-19} \text{C}$
$R^2$	Correlation coefficient
$R_p$	Relative power of the panel
$S$	cell area
$T$	Temperature
$t_i$	$i^{\text{th}}$ receiver's duration of the functioning of the loads in the day
$V$	Voltage
$V_{AC}$	Alternative current voltage
$V_{bat}$	Nominal voltage of the battery
$V_{DC}$	Direct current voltage
$V_{isof}$	Isòfoton panel voltage
$V_m$	Maximum output voltage
$V_{oc}$	Open circuit voltage
$V_{suns}$	Sunshine Solar voltage

#### GREEK LETTERS

$\alpha$	Photo generation constant
$\eta$	Efficiency of a cell
$\eta_{bat}$	Efficiency of the battery
$\eta_{gen}$	Efficiency of the PV modules

## GENERAL INTRODUCTION

Energy is vital. Energy is used for several activities such as lighting, cooking, communication, pumping, education, health services, transport, water heating, power generation, agriculture, and industry, commercial and so on. Energy improves human life quality. However, some people around the world have no access to the modern forms of these energies. For instance, compared to the industrialized countries, African countries are facing the challenge to meet a minimum level of energy demand and services for a greater number of poor population (**Karekezi, 2002**). Energy production and its conversion are not without impacts, leading to some global environmental emissions issues (acid precipitation, pollution, climate change). Also, many studies (**National Climate Assessment, 2014; U.S. Global Change Research Program, 2014; NASA**) have shown that climate is changing and the world global energy demand has some impacts on climate change (**Usenobong F. Akpan and Godwin E. Akpan, 2012; Bharat Raj Singh and Onkar Singh, 2012**). Indeed, climate change will increasingly impact Africa due to many factors such as energy demand growth, population growth, economic growth, etc. To meet its energy demand like other continents, Africa needs to rely on energy sources which are renewable at human life scale (wind, Sun, ocean, geothermal) which are the most abundant on the continent. Renewable energy has increasingly become a solution to cope with energy issues (availability, access, global environmental issues, cost...). However, the use of Sun as a source of energy is old as humankind (**California Energy Commission**). According to contemporary solar engineers, solar power is eminently practical (**Charles Smith, 1995**). Nowadays, one of the most renewable energy to develop in Africa is solar energy which is sufficiently great to provide the electricity needs for all. Solar energy technology mostly widespread is photovoltaic (PV) system (**figure 0-1**). During the past two decades, a tremendous progress has been made on the solar energy technologies, particularly in photovoltaics (PV) (**Ibrahim Dincer, 1999**). The development of this technology is likely to enable to meet living-wage and to cope with climate change that our world fights. PV technologies that are typically around 1-5 kW<sub>p</sub>, are used in off-grid domestic systems providing electricity for lighting, pumping and other low power loads in remote areas or villages that are not connected to the grid. However, for commercial purposes such as health centers, schools, telecommunication, water pumping and business, an off-grid non-domestic system is the most appropriate (**CNES, 2015**).

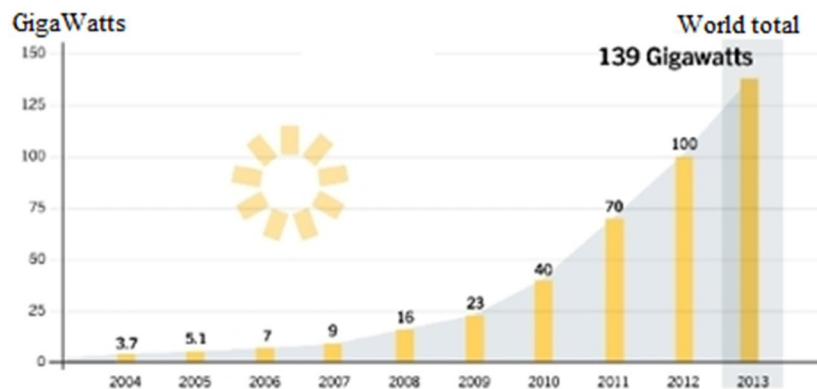

Figure 0-1: Solar PV Total Global Capacity, 2004-2013 (Source: REN21 Secretariat, 2012)



In Africa, solar radiation is mostly concentrated in the western part (**figure 0-2**). Niger is located between 11.37 to 23.33N of latitude and has a huge potential for high solar power generation (**figure 0-3**). In Niger, the average period sunshine varies between 7 and 10 hours per day while the average solar energy potential range from 5 to 7 kWh/m<sup>2</sup>/day (CNES, 2015). Like other developing countries, Niger has to address energy challenges: over growing population, poor and aging energy infrastructure, demand-side management, needs of increasing access to electricity (growth demand), and reliability increased to avoid power outages. Niger is constantly struggling to meet its daily energy demand. Energy is a challenge in Niger because a long-term energy solution has not been developed (Yacouba Moumouni et al., 2014). Whence, in Niger, there are several electrification programs in order to meet energy demand, to improve the life of the population and their incomes, and to mitigate climate change by replacing conventional energy fuels. Most of the programs involve solar PV systems where the target population is mostly in rural areas where there is no access to electricity. This rural electrification program relies largely on international donors even if Niger has begun to allocate funding to meet the cost of implementing decentralized renewable technologies for a range of social development needs (IRENA, 2013). Recently, the private sector, particularly led by the telecommunication one, is developing programs relying on the use of solar energy.

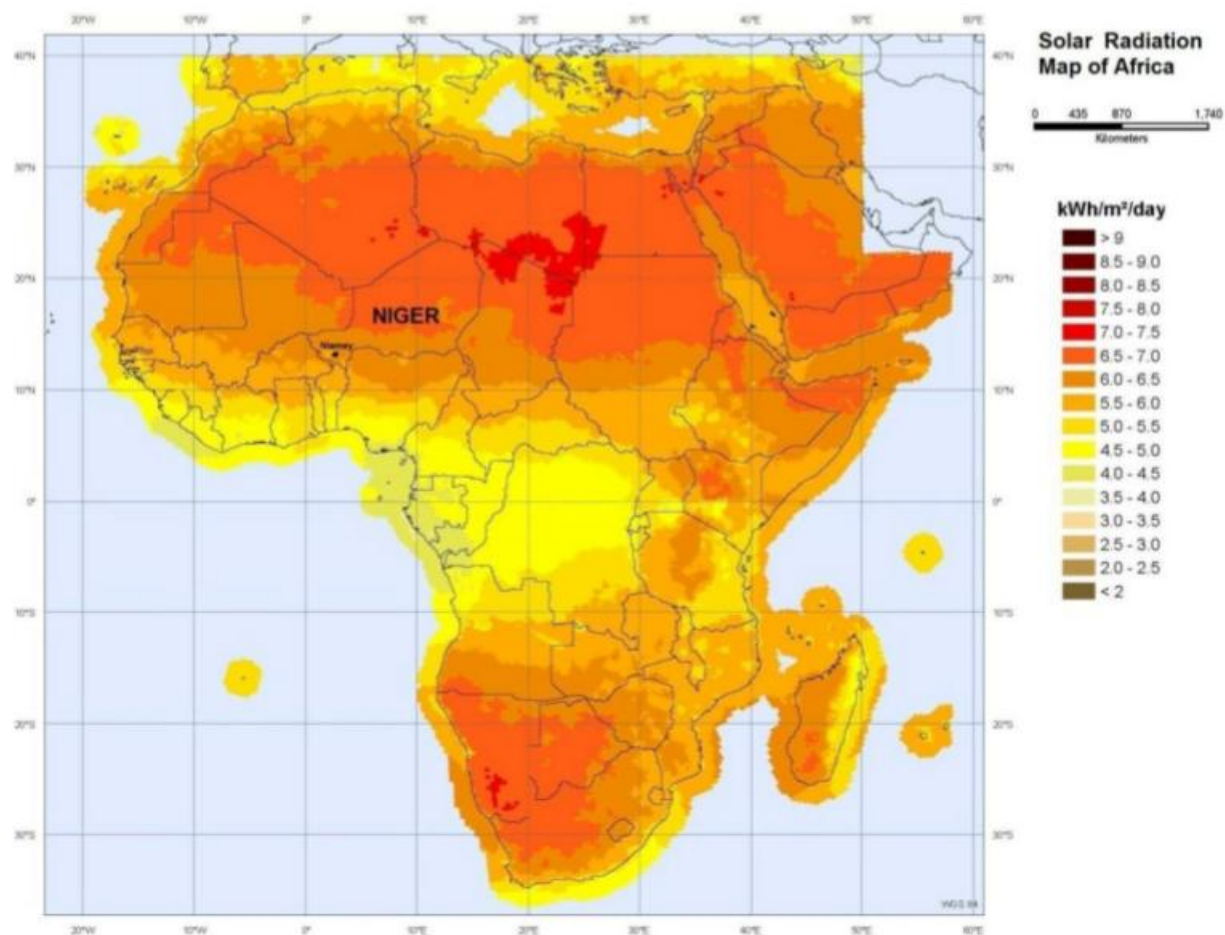

Figure 0-2: Africa Radiation Map (Source: NREL).



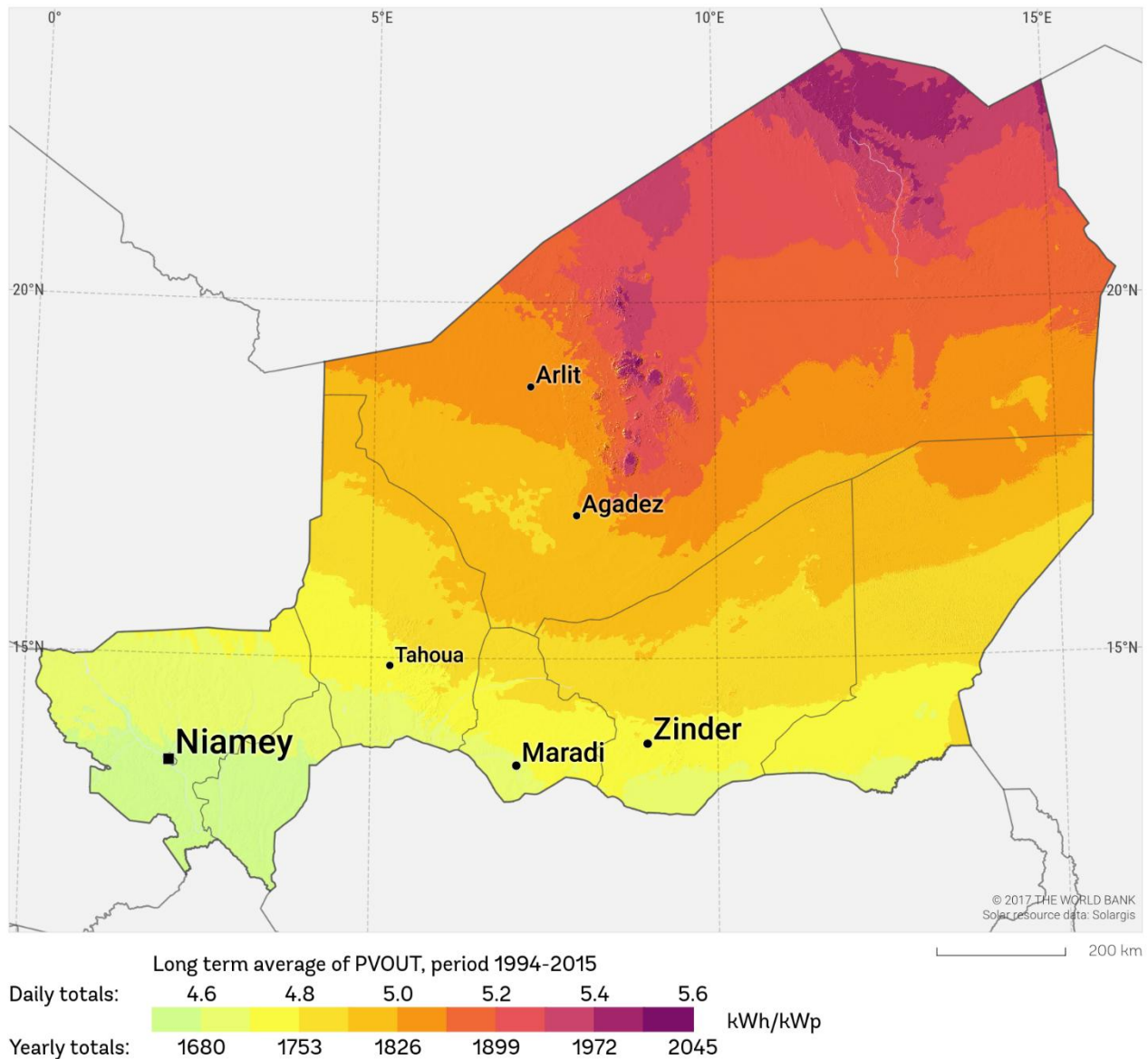

Figure 0-3: Niger PV Power Potential Map (Source: World Bank Group).

Therein, PV systems have revolutionized rural energy field, enabling possible access to energy even for the remote population. However, environmental and meteorological conditions (irradiance, temperature, humidity, dust, wind...) affect PV systems performance according to their geographical location. Also, solar technology exploitation can drive to some impacts, both social and economic, on the target population. Moreover, with further new developments performance, PV system can be more reliable than other forms of energy technology. Indeed, PV technology embodies a vision of a sustainable energy system with reduced environmental emissions (pollution, GHGs) through the substitution of conventional energy sources (coal, foods, natural gas) (IEA-PVPS T8-01, 2015). Hence, within the frame of strategies and solutions of climate change adaptation-mitigation, sustainable energy, and energy efficiency, PV systems performance assessment can contribute for PV systems efficiency improvement in order to adapt PV technology to areas sharing the same environmental and/or meteorological conditions in Niger and other countries. Whence, this study characterizes the performance of a mini PV system (pumping and generator) installed in Niger's

rural area which can be influenced either by the tilted angle and orientation of the PV panels, or the environmental and meteorological. Furthermore, this work concerns also the assessment of the socioeconomic impacts of operating PV technology in a rural area that can help stakeholders to ascertain and raise human well-being by boosting economy too.

## Objectives

The main objective of this study is to characterize the performance of PV systems in the rural area of Niger named Sarando Bené as well as the socio-economic impacts on native and/or surroundings population of Kobadjé village.

Specifically, this study attempts to evaluate:

- the local environmental and meteorological conditions (solar radiation, ambient, and modules temperature, dust) impacting the performance of solar PV panels, pump, batteries, charge controller and inverter but also estimate power and daily energy output that is produced by the systems;
- the socioeconomic impacts of rural off-grid PV systems.

## Methodology

Firstly, the methodology consists of doing experiences on PV systems (pumping system, domestic) under real environmental and climatic conditions of Sarando Bené. To determine the technical performances of this mini solar platform, it has been done manually data record of voltage, current, dynamic and static height, pump flow, panels slope while CR1000 datalogger recorded voltage, current, ambient and modules temperature, solar radiation. The data logger recorded data during three (3) weeks. The experiences have been conducted when the PV panels were cleaned and not. The output data will lead to see the trends of solar radiation and its impact

Secondly, it consists of elaborating surveys through the software sphinx and conducting a physical survey in Kobadjé and surrounding in order to assess the socioeconomic impacts of off-grid PV systems (domestic and non-domestic).

## Thesis Structure

This thesis is divided into four (4) chapters. The first chapter introduces first about the several parameters (physics of the solar radiation) that intervene in solar PV energy conversion, then the photovoltaic system characteristics, and finally the use of PV technology in Niger. The second chapter deals with parameters (PV slope and orientation, solar radiation, temperature, humidity, dust) that affect the technical performance of PV panels and the use of PV systems in the scientific literature. The third chapter presents firstly a brief presentation of study areas, then focuses on presenting materials and methodology used in collecting data. Finally, the last chapter gives results of the experiences that are analyzed and discussed.

## **Chapter I: SOLAR ENERGY CONVERSION AND USE: CASE OF PHOTOVOLTAIC SYSTEM**

## Introduction

Radiation is energy. The Sun emits radiation in the entire electromagnetic spectrum that ranges from longwave to shortwave radiation. The sequence from longest wavelength to shortest wavelength is a sequence in energy from lowest energy to highest energy. Several models, some simpler than others permit to estimate the global solar radiation. However, isotropic and anisotropic sky models are mostly used to compute solar radiation either on horizontal or on tilted surfaces. Thus, several series of equations are used to compute solar radiation models and solar cells parameters but also to understand the factors that are involved in PV system functioning and dimensioning.

Indeed, PV technologies consist of solar cells which are mostly semiconductors. So, a solar cell converts solar energy into electrical energy by employing the photovoltaic effect (**G.N. Tiwari and Swapnil Dubey, 2010**). The major types of PV cells materials are namely crystalline cells (m-Si, p-Si, a-Si) and organic cells but a newly introduced kind of solar cells, Nano PV cells (**S. Mekhilef, R. Saidur and M. Kamalisarvestani 2012**). PV technologies work as long as there is sunlight. Sub-Sahara-African countries have a great potential of solar radiation.

Solar energy is used as a solution for rural electrification in many Sub-Sahara-African countries like Niger. The National Centre of Solar Energy (Centre National de l'Énergie Solaire) in Niger in one of its main goals, has inventoried and estimated in 2014, the country's energetic power from renewable source available and utilized. The main source inventoried and estimated comes from solar energy, with as high as 5 MWp. This has been done in 1993 and 2006, too.

The major topics in this chapter concern the fundamentals and characteristics of solar radiation and PV technologies, a description of some software used in PV system analysis, and also the utilization of PV panels in a particular region of the world (case of Niger).

### 1.1. Solar Radiation

#### 1.1.1. Sun Position in the Sky

For most solar energy applications, one needs reasonably accurate predictions of where the sun will be in the sky at a given time of day and year. The sun position with respect to an observer on earth (**figure 1-1**) can be fully described by means of two astronomical angles, the solar altitude ( $\alpha$ ) and the solar azimuth ( $z$ ). The following is a description of each angle, together with the associated formulation.

The sun's position in the sky described with several angles is indicated in **figure 1-1** below. In this figure, there is an inclined plane to show the relative angles between the sun and a tilted surface.

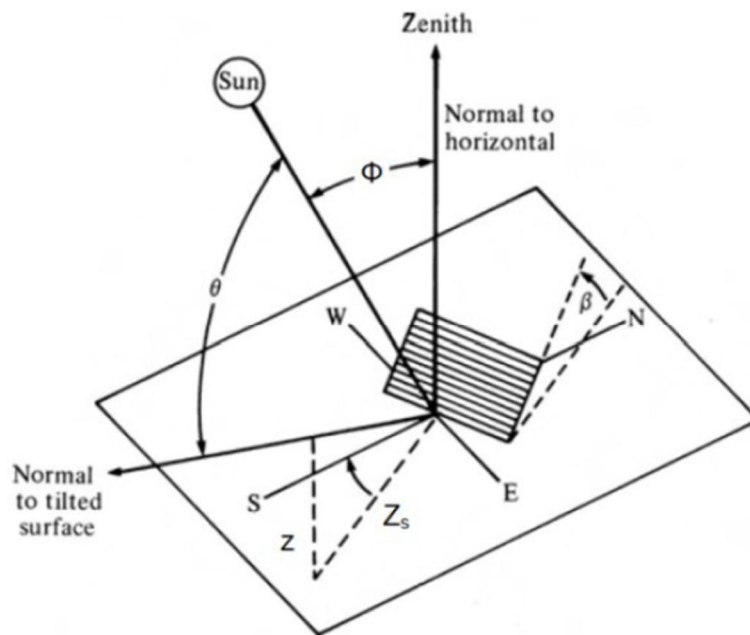

Figure 1-1: Surface-Sun angles (Source: J.A. Duffie and W.A. Beckman, 1980)

Where:

- $\beta$  tilt angle, is the slope of the plane surface from horizontal position (with  $0 < \beta < 90$  for a surface facing towards the equator;  $90 < \beta < -90$  for a surface facing away from the equator).
- $\phi$  solar zenith angle is the angle of incidence of direct radiation on a horizontal plane. It is the angle between the solar beam and the normal on the horizontal and is called zenith angle.
- $\theta$  angle of incidence is the angle between solar beam and surface normal.
- $Z$  solar azimuth angle is the angle between the solar beam and the longitude meridian. In other words, it is the angle between the south and the horizontal projection of direct radiation. In the northern hemisphere,  $Z$  equals  $0^\circ$  for a surface facing due south,  $180^\circ$  due north,  $0^\circ$  to  $180^\circ$  for a surface facing westwards and,  $0^\circ$  to  $-180^\circ$  eastward.
- $Z_s$  surface azimuth angle is the angle between the south direction and the direction where the plane is facing or it can be said that it is the angle between the normal to the surface and the local longitude meridian. For a horizontal surface,  $Z_s$  is  $0^\circ$  always.

Solar altitude and solar zenith angles are complementing each other,  $\alpha + \phi = 90^\circ$  with  $\text{Sin}(\alpha) = \text{Cos}(\phi)$ .

Solar altitude angle ( $\alpha$ ) and azimuth angle ( $\phi$ ) are indicated in the plot by dates and times. As it can be seen, the height of the sun reaches its minimum amount in December and maximum amount in June (Duffie and Beckman, 1974). In Figure 1-2 the solar position in the sky is shown for the latitude of  $40^\circ$  North.

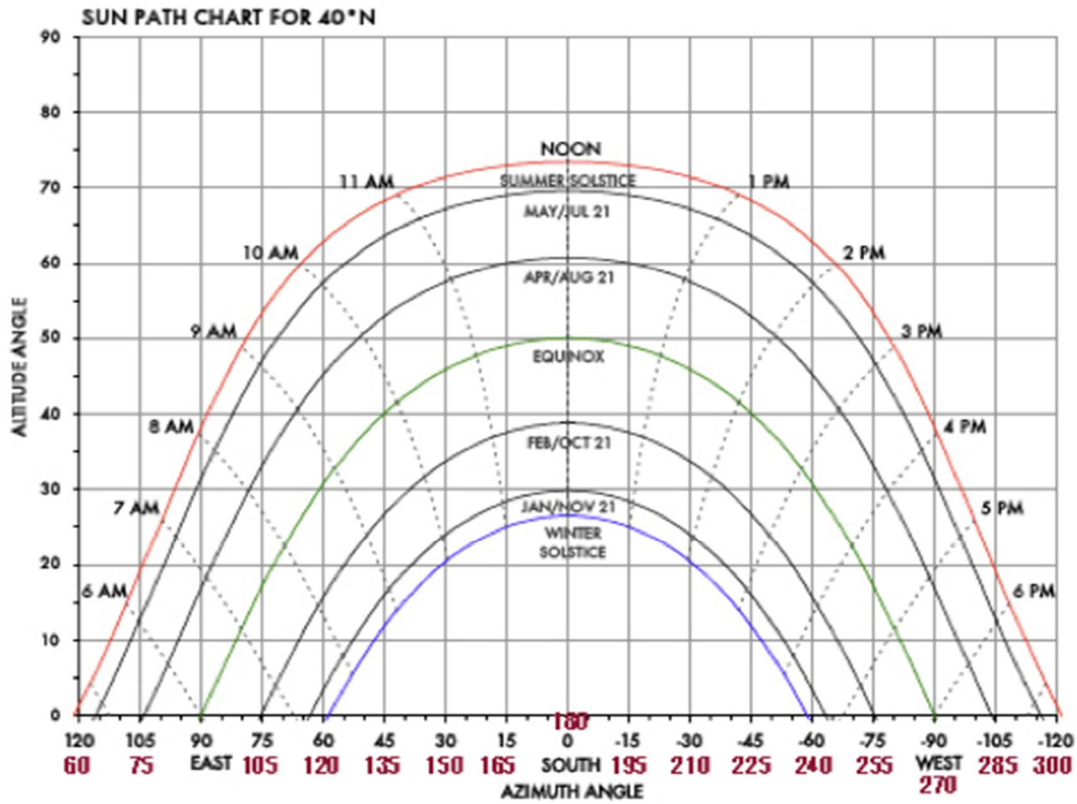

Figure 1-2: Sun's path in the sky (Source: New Energy Research)

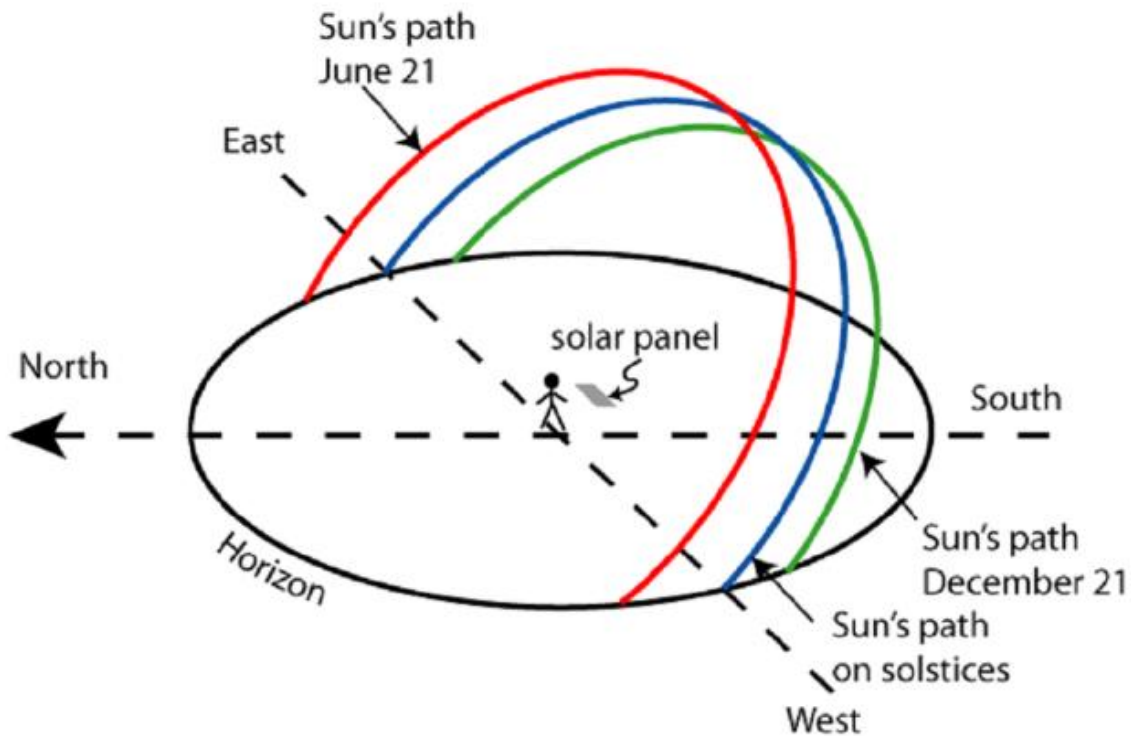

Figure 1-3: Annual changes in sun's position in the sky (Source: Akram Abdulameer Abbood Al-Khazzar, 2015)



### 1.1.2. Fundamentals of Solar Radiation

Duffie and Beckman in 1974 presented an equation that gives an almost accurate amount of extraterrestrial radiation as a function of the day number ( $n$ ). The solar constant  $I_s$  has been estimated as  $1367 \text{ W/m}^2$  with an uncertainty in the order of 1%.

The energy reaching the earth depends on the geometry of the earth relative to the Sun. This geometry is described as well as its variation throughout the year. The concept of time is very important in solar radiation. Solar time is time based on the apparent angular motion of the Sun across the sky, with solar noon the time the Sun crosses the meridian of the observer (Duffie and Beckman, 1974). It is the time used in all sun-angle relationships. Thus, solar time is given by:

$$\text{Solar time} - \text{Standard time} = 4(L_{st} - L_{loc}) + E \quad (1)$$

Where:

- The Sun takes 4 minutes to transverse  $1^\circ$  of longitude;
- $L_{st}$  is the standard meridian for the local zone time zone;
- $L_{loc}$  is the longitude of the location in question; and
- $E$  the equation of time in minutes:

$$E = 229.2(0.00075 + 0.001868 \cos B - 0.032077 \sin B - 0.014615 \cos 2B - 0.04089 \sin 2B) \quad (2)$$

And:

$$B = (n - 1) \frac{360}{365} \quad (3)$$

$n$ , day of the year. Thus  $1 \leq n \leq 365$ .

In fact, it has been demonstrated that the sun emits radiation within a particular range of wavelength called solar spectrum.

### 1.1.3. Solar Spectrum

The solar spectrum typically extends from the IR to the UV region (**figure 1-4**), a wavelength ranges from  $3 \mu\text{m}$  to  $0.2 \mu\text{m}$ . But the intensity is not uniform. The solar spectrum can be approximated by a black body radiation curve at temperature of approximately  $5250^\circ\text{C}$ . There is also a difference in the spectra measured at the top of the atmosphere and at the surface, due to atmospheric scattering and absorption.

When solar radiation passes through the atmosphere of the Earth, it is attenuated. The most important parameter that determines the solar irradiance under clear sky conditions is the distance that the sunlight has to travel through the atmosphere (**Delft University of Technology, 2014**).

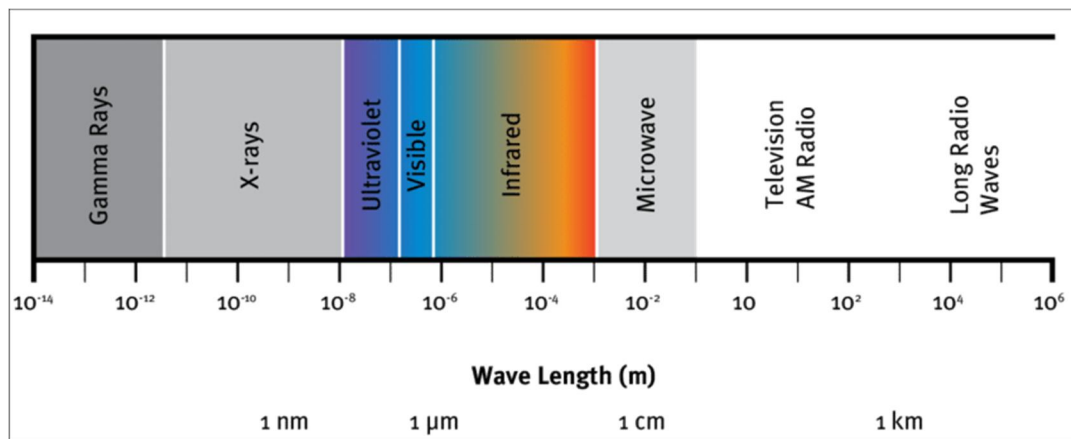

Figure 1-4: Solar Spectrum Chart (Source: Short N.M. NASA remote sensing tutorial)

The following **figure 1-5** illustrates the spectrum of solar irradiance regarding its wavelength.

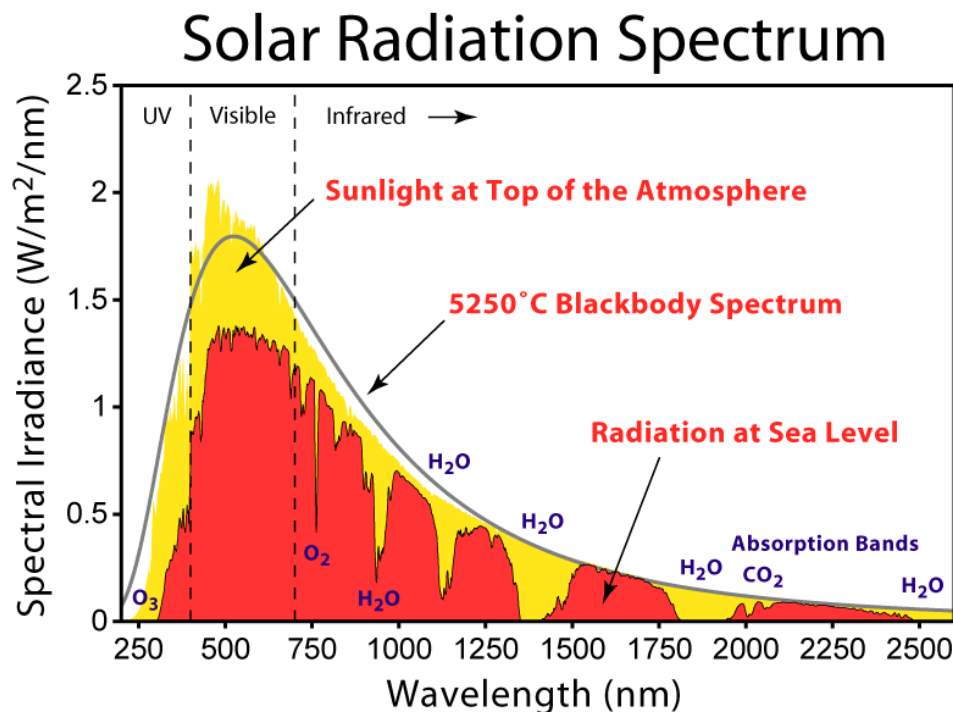

Figure 1-5: Solar radiation spectrum regarding its wavelength (Source: Wikipedia, 2015).

PV modules are sensitive to visible light (due to glass coverage), but crystalline silicon (c-Si) is sensitive to both visible and infrared solar radiation. About 40% of solar irradiance is visible light, while 10% is ultraviolet, and 50% is infrared radiation. However, on the Earth's surface, evaluation of the solar irradiance is more difficult because of its interaction with the atmosphere through scattering, absorption, and reflection (**figure 1-5**). The atmosphere contains clouds, aerosols, water vapor and gases tracers that vary both geographically and temporally. In fact, the path that the incoming solar radiation will take to travel through before reaching the earth surface is so-called air mass.



### 1.1.4. Air Mass

It is the ratio of the mass of atmosphere through which beam radiation passes to the mass it would pass through if the sun were at the zenith. Sign convention is AM. Thus, at sea level AM = 1 when the sun is at the zenith and AM = 2 for a zenith angle  $\phi$  of 60°. For zenith angles from 0° to 70° at sea level, to a close approximation,

$$AM = \frac{1}{\cos \phi} \quad (4)$$

With:

$$\phi = \cos^{-1}(\cos(\varphi) * \cos(\delta) * \cos(h) + \sin(\varphi) * \sin(\delta)) \quad (5)$$

Where:

- $\phi$  is the local latitude, values north of the equator are positive and those south are negative,  $-90 < \phi < 90$ ;
- $\delta$  is the declination angle determined by:

$$\delta \cong 23.45^\circ * \sin \left[ \frac{360(n+284)}{365} \right] \quad (6)$$

With n, the day in the year (n = 1 on 1 January).

- h is the hour angle; angle through which the Earth has rotated since solar noon. Since the Earth rotates at  $360^\circ/24$  hours =  $15^\circ/\text{hour}$ . The hour angle is positive in the evening and negative in the morning, the hour angle is given by:

$$h = (\text{solar time} - 12) * 15^\circ \quad (7)$$

By definition, the AM0 is the case of extraterrestrial radiation (i.e. no air mass at all). AM1.5 is commonly used as a reference air mass in data sheets of PV modules. During the sunrise and the sunset, the zenith angle becomes higher resulting in a higher air mass value. The higher air mass coefficient is, the lower the direct irradiation and the higher the diffused irradiation because of the absorption and collision. **Figure 1-6** shows the various air mass values for different zenith angle.

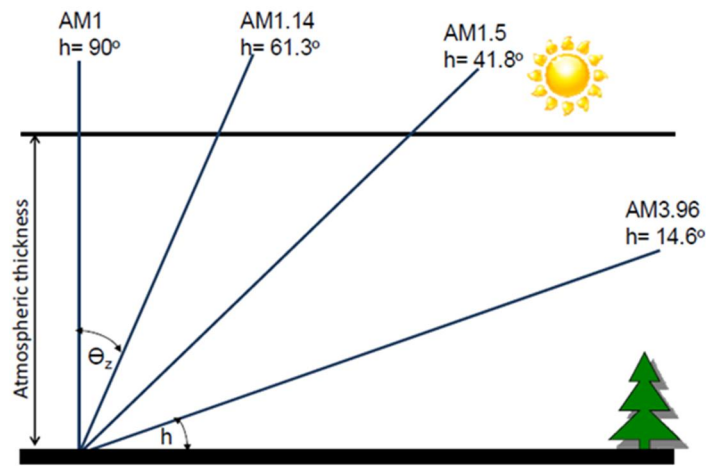

Figure 1-6: Various air mass and corresponding zenith angles in a plane parallel atmosphere (Source: Qasem, 2007)

The Air Mass 1.5 (AM1.5) is given as the standard test condition in solar cell design (**Virtuani et al., 2006**).

### 1.1.5. Clearness Index

The linkage between the hourly and daily extraterrestrial irradiance (AM0) and the integrated energy density gathered from a horizontally mounted pyranometer, is termed as clearness indices.  $I_0$  is solar constant and equals to  $0.0082 \text{ MJ/m}^2/\text{min}$ .

$$k_G = \frac{I}{I_0} \quad (8)$$

$k_G$  is the hourly clearness index for global radiation (that is what the “G” is for). This is the ratio of measured energy density against energy density for extraterrestrial radiation in one hour.

$$K_G = \frac{H}{H_0} \quad (9)$$

$K_G$  is the daily clearness index for global radiation. This is the ratio of measured radiation against energy density for extraterrestrial solar in one day.

$$\overline{K_G} = \frac{\overline{H}}{H_0} \quad (10)$$

$\overline{K_G}$  is the monthly average daily clearness index for global radiation. This is the ratio of measured energy density averaged over the month as one day against energy density for extraterrestrial solar for an average day.

### 1.1.6. Solar Energy Measurement

To assess the availability of solar radiation at different locations, measurements of global radiation, diffuse radiation, beam radiation, sunshine hours, bright sunshine hours, maximum and minimum temperature, humidity, pressure, visibility, wind speed and direction, gust speed, water precipitation, and air mass are very important parameters (**Pandey and Katiyar, 2013**).

The solar radiance is an instantaneous power density in units of  $\text{kW/m}^2$ . The solar radiance varies throughout the day from  $0 \text{ kW/m}^2$  at night to a maximum of about  $1 \text{ kW/m}^2$ . The solar radiance is strongly dependent on location and local weather. Solar radiance measurements consist of global and/or direct radiation measurements taken periodically throughout the day. The measurements are taken using either a pyranometer (measuring global radiation) and/or a pyrheliometer (measuring direct radiation).

The solar irradiance can also be estimated from satellite data. Several attempts have also been done to calculate the solar radiation on surfaces using models.

### 1.1.7. Solar Radiation Models on Tilted Surfaces

It is generally accepted that models for solar radiation prediction are necessary because in most cases the density and number of solar radiation measuring stations cannot describe the necessary variability (**Muneer et al., 2007**). Radiation models are used to estimate the solar radiation on horizontal and inclined surfaces. The mathematical models used to determine the amount of tilted surface solar radiation can be classified into two types of models namely isotropic and anisotropic. It should be noted that solar radiation reaching the Earth can be direct, diffuse or reflected radiation (**figure 1-7**)

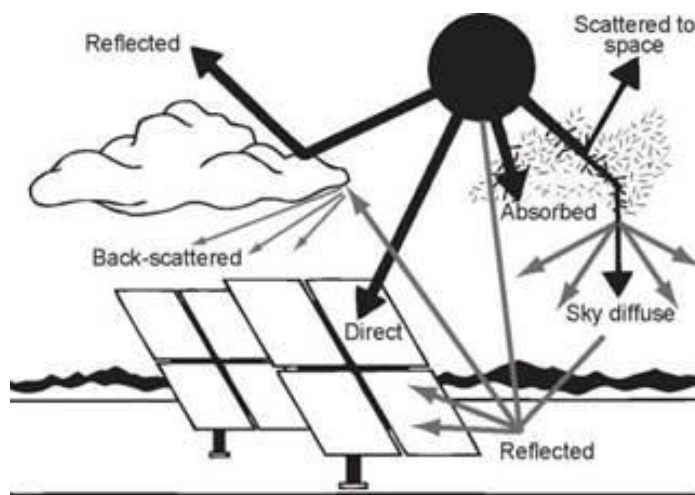

Figure 1-7: Solar Radiation Components (Source: Energy Professional Symposium)

Hottel and Woertz were the first who assumed that the combination of diffuse and ground reflected radiation is isotropic (**A.Q Jakhani, 2013**). That, the sum of diffuse from the sky and

ground reflected radiation on the tilted surface is the same regardless of orientation. Thus, the total radiation on the tilted surface is the sum of beam radiation and the diffuse radiation.

In sum, according to several authors (**Hottel and Woertz, 1942 as cited by Duffie and Beckman, 1991; Liu and Jordan, 1960**), the isotropic models assume that the intensity of diffuse sky radiation is uniform over the sky dome and that reflection on the ground is diffuse.

The anisotropic models assume the anisotropy of the diffuse sky radiation in the circumsolar region (sky near the solar disk) plus and isotropically distributed diffuse component from the rest of the sky dome (**A.M. Noorian et al., 2007**). The anisotropic sky models were developed by various researchers to incorporate the contribution of circumsolar and horizon brightening components isotropic sky models (**A.Q. Jakhrani, 2013**). Almost, all researchers took the same value of the beam and reflected part of radiation as recommended by Liu and Jordan and amended only the part of diffuse radiation.

For a cloudy sky, it is valid to use the isotropic sky model to estimate the hourly solar radiation on a tilted surface.

All these radiations models are used in PV software's to model and calculate the irradiance upon surfaces.

## 1.2. Solar PV Design and Simulation Software

PV software's are used to design, simulate PV systems and estimate their efficiency, power output, irradiance, etc. Mostly, meteorological databases and radiation models are used over these various software packages to calculate the solar irradiance on PV modules. Among the commonly used we have: Homer Pro – Homer Energy, USA; PV F-Chart – F-Chart software, USA; pvPlanner – SolarGis, Slovakia; Pvsyst – Pvsyst SA, Switzerland; RETScreen – Natural Resources Canada, Canada; System Advisor Model (SAM) - National Renewable Energy Laboratory (NREL), USA; Solar Pro – Laplace Systems, Japan. In this study, the first four models are presented as summarized in **Table 1-1**.

*Table 1-1: General outline of main solar design and simulation software.*

	Stand Alone	Grid-Connected	Hybrid System
PVsyst	<i>for the study, sizing and data analysis of complete PV systems</i>	<i>for the study, sizing and data analysis of complete PV systems</i>	
HOMER			<i>Simulation, Optimization and Sensitivity Analysis</i>
RETScreen			<i>technical and financial viability of potential renewable energy</i>
SAM	<i>performance and financial model</i>	<i>performance and financial model</i>	<i>performance and financial model</i>

### 1.2.1. PVsyst Software

Developed by Swiss physicist Andre Mermoud and electrical engineer Michel Villoz, this software is considered a standard for PV system design and simulation worldwide. PVsyst is a PC software package for the study, sizing and data analysis of complete PV systems. It deals with grid-connected, stand-alone, pumping and DC-grid (public transportation) PV systems, and includes extensive meteo and PV systems components databases, as well as general solar energy tools (**General description of PVsyst software**).

### 1.2.2. Homer for Grid and Off-Grid Power System

Homer Energy is a micro-grid optimization software. HOMER stands for Hybrid Optimization Model for Multiple Energy Resources and comes with Simulation, Optimization, and Sensitivity Analysis tools. HOMER simulates energy systems, shows system configurations optimized by cost, and provides sensitivity analyses (**HOMER PRO 3.11 manual's user**).

HOMER works on grid or off. HOMER shows you how to cost-effectively combine renewable systems with grid power for maximum reliability. HOMER combines multiple power sources to create one robust micro-grid system that meets your electrical load while saving fuel. HOMER navigates the complexities of building cost-effective and reliable micro-grids that combine traditionally generated and renewable power, storage, and load management. Homer will simulate different system configurations, or combinations of components, and generates results, with a list of feasible configurations sorted by net present cost (**Homer's user guide**).

### 1.2.3. RETScreen Software

Developed by National Resources Canada it is an Excel-based clean energy project analysis software tool that helps decision makers quickly and inexpensively determine the technical and financial viability of potential renewable energy, energy efficiency, and co-generation projects. RETScreen is a Clean Energy Management Software system for energy efficiency, renewable energy and cogeneration project feasibility analysis as well as ongoing energy performance analysis. A free program consisting of a macro enabled spreadsheet that has all the formulae in place to calculate various sorts of energy sources including solar PV and allows the user to calculate PV power generation based on location, do a cost analysis and determine project feasibility.

### 1.2.4. System Advisor Model (SAM) Software

The System Advisor Model (SAM) is a performance and financial model designed to facilitate decision making for people involved in the renewable energy industry (Project managers and engineers; Policy analysts; Technology developers and Researchers). It is intended to help potential users determine whether the model meets their modeling needs (**SAM NREL general description, 2014**). SAM makes performance predictions and cost of energy estimates for grid-connected power projects based on installation and operating costs and system design parameters specified by the user (**Eslam Allam, 2017**).

SAM's performance models make hour-by-hour calculations of a power system's electric output, generating a set of 8,760 hourly values that represent the system's electricity production over a single year (SAM NREL general description, 2014).

SAM's models help in determining and improving the performance of PV Systems.

## 1.3. PV System

### 1.3.1. Principle of a PV Effect

The photovoltaic effect can be described as a generation of an electromotive force (voltage) within the range of materials non-homogeneity during light illumination with an appropriate wavelength. The PV effect has been discovered in 1839 by Becquerel during the study of two (2) metallic electrodes in a conducting solution: Becquerel observed an appearing voltage when electrodes were illuminated (R. Trykozko, 1997).

When sunlight strikes the solar cell, electrons are knocked loose. They move toward the treated front surface. An electron imbalance is created between the front and back (figure 1-8). When the two surfaces are joined by a connector, like a wire, a current of electricity occurs between the negative and positive sides.

In most photovoltaic applications the radiation is sunlight, and the devices are called solar cells. In the case of a p-n junction solar cell, illuminating the material creates an electric current as excited electron and the remaining holes are swept in different directions by the built-in electric field of the depletion region. The main element of the PV cell is a p-n junction which forms also a basic element in solid-state electronics.

This description does not broach the complexity of the physical processes involved.

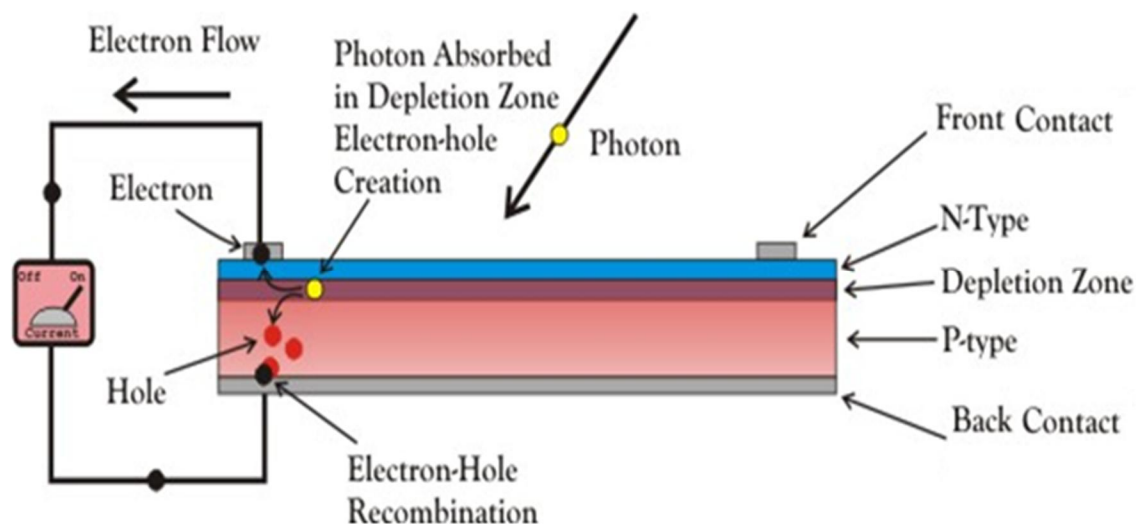

Figure 1-8: Solar cell P-N junctions (Modified from electrical4u.com, accessed on 21/04/2017).

### 1.3.2. Description of a PV Cell

Solar Cell converts light energy into the electrical energy based on photovoltaic effect. Solar cells are made of semiconductor materials. A PV cell is a semiconductor p-n junction photodiode that can generate electrical power when exposed to light (**Said, et al. 2012**). A solar cell produces continuous current, but its energy yield will be in function to the sunlight received by cell primarily. Solar cells are the building blocks of photovoltaic modules, otherwise known as solar panels.

In the early stages, the solar cell was developed only with 4 to 6% efficiency because of inadequate materials and problems in focusing the solar radiations. But, after 1989, the solar cells with more than 50% efficiency was developed (**SRM University, 2013**). Nowadays, several types of semiconductor materials are used for PV cells production, but most commonly used is silicon (Si) – crystalline, polycrystalline, and amorphous. The overwhelming majority of solar cells produced worldwide are composed of the semiconductor material Silicon (Si). As the second most abundant element in earth's crust, silicon has the advantage of being available in sufficient quantities. Solar cells are also fabricated from other semiconductor materials such as GaAs, GaInP, Cu(InGa)Se<sub>2</sub>, and CdTe, to name but a few. Solar cell materials are chosen largely on the basis of how well their absorption characteristics match the solar spectrum and upon their cost of fabrication (**L.J. Gray, 2011**). Silicon has been a common choice due to the fact that its absorption characteristics are a fairly good match to the solar spectrum, and silicon fabrication technology is well developed as a result of its pervasiveness in the semiconductor electronics industry (**L.J. Gray, 2011**). The most common types known commercially are mono-crystalline (m-Si), polycrystalline (p-Si) and amorphous silicon (a-Si) (**Said et al., 2012**).

### 1.3.3. P-N Junction in Semi-Conductor

The semiconductor layers are the most important parts of a solar cell; they form the heart of the solar cell. There are a number of different semiconductor materials that are suitable for the conversion of energy of photons into electrical energy, each having advantages and drawbacks. The most commonly known solar cell is configured as a large-area p-n junction made from silicon. A diode is formed by a p-n junction with the p side call anode and N side cathode. Other possible solar cell types are organic solar cells, dye-sensitized solar cells, perovskite solar cells, quantum dot solar cells etc.

To produce a solar cell, the semiconductor is “doped”. “Doping” is the intentional introduction of chemical elements into the almost semiconductor. For example, about one boron atom for every million silicon atoms (**SERI, 1981**). By doing this, depending upon the type of dopant, one can obtain a surplus of either positive charge carrier (called p-conducting semiconductor layer) or negative charge carriers (called n-conducting semiconductor layer). When the n and p materials are in contact, free electrons in the n-type material adjacent to the many holes in the p-type material at the junction will jump into the p-type material, filling the holes. Also, valence band electrons on the n-type side can jump into holes on the adjacent p-type side, which is equivalent to a hole moving over into the n-type material. This charge transference process happens rapidly along the dividing line (junction), sending huge numbers of electrons to the p-type side and holes to the n-type side. This causes an



immediate imbalance of charge: more negative charges (extra electrons) along the p-type side of the interface, more positive charges (ions) along the n-type side.

When electrons move over into the p-type material during junction formation, they find holes in the silicon bonds and drop into them. In like manner, holes that transfer to the n-type side are quickly filled by the n-type side's numerous extra electrons. Consequently, carriers that form the junction lose their freedom of movement. Thus, although a charge imbalance exists at the junction, there are very few free electrons on the p-type silicon side to be pulled back to the n-type side, and very few free holes on the n-type side to be transferred back to the p-type material. So, the charge imbalance stays fixed in place. (SERI, 1981).

### 1.3.4. Notion of Photoconductivity

Photoconductivity is an important property of semiconductors and is also a complex phenomenon. It can be defined as the change in the electrical conductivity of a crystal under the action of absorbed radiation, being increasingly utilized to study other processes in semiconductors (V. S. Vavilov, 1965). Thus, in the semiconductors studied most (germanium, silicon, and certain intermetallic compounds), it has become possible to control, within a wide range, the photosensitivity spectrum, response, and other properties important in the practical applications of these materials.

The electrical conductivity of a homogeneous semiconductor  $\sigma$  is given by the formula:

$$\sigma = q(n\mu_n + p\mu_p) \quad (11)$$

Where:

- $q$  is the electronic charge,
- $n$  and  $p$  are respectively the free electron and hole densities,  $\mu_n$  and  $\mu_p$  are their mobilities.

A photoconductivity  $\Delta\sigma$  appears if, as a result of the absorption of radiation, the values of  $n$  and  $p$  increase compared with their values at thermal equilibrium:

$$\Delta\sigma = q(\Delta n\mu_n + \Delta p\mu_p) \quad (12)$$

In semiconductors with a wide forbidden band or at low temperatures, the values of  $\Delta n$  and  $\Delta p$  may be considerably higher than the corresponding equilibrium (dark) densities  $n_0$  and  $p_0$ .

In an inhomogeneous semiconductor, for which the values of  $n_0$  and  $p_0$  vary from one region to another, the photoconductivity may be due to more complex effects, such as a change in the resistance of barriers between grains (crystallites) as a result of radiation.

However, the effect of photoconductivity is not very pronounced at high temperatures except when the illumination is by an intense beam of light.



### 1.3.5. Conception of a Solid Crystallized PV Module

The commonly used material to make up a PV cell is silicon. It is made up from quartzite sand (silicon dioxide). The early c-Si (**figure 1-9**) based p-n junction solar cell came into existence in 1941 at Bell Laboratory by Russel Ohl (**Green, 2002**). The monocrystalline silicon (m-Si) consists of melting in the presence of carbon high-purity, semiconductor-grade silicon having only a few parts per millions of impurities in a crucible at 1425°C. During this melting process, dopant impurity atoms such as boron (for p-type semiconductor) or phosphorus (for n-type semiconductor) are added to the molten silicon to dope the silicon. Then, the second step consists to dip a rod-mounted seed crystal into the molten silicon. The seed crystal has a well-defined crystal orientation. Next, the crystal's rod is carefully pulled out and rotated simultaneously. The temperature gradients, the pulling-rate and the rotation speed must be controlled precisely. Doing so results in the extraction of a large, single-crystal, cylindrical ingot from the melt. The melting process needs both, an inert atmosphere (e.g. argon) and an inert chamber (e.g. quartz). The disadvantages of the classical melting process are the very low speed and the energy intensive production costs. In addition, the ingot must be sawed in order to produce thin solar cell wafer. However, Solar cells based on Poly-Si manufacturing are very similar to monocrystalline modules (**figure 1-10**). Poly-Si cells are fabricated from pure molten Si in a square-like tank; the cooling down is an essential step because it determines the grain size and the distribution of impurities. The obtained ingots are cut in bars with a cross-section of 15.6 cm x 15.6 cm; finally, they are sawn to get thin wafers. This fabrication process gives life to a multi-grain crystal structure. Compared to monocrystalline Si, the structure is less ideal resulting in a loss of efficiency (of about 1% compared to m-Si), but this drawback is overcome by lower wafer costs. A second advantage is the arrangement of the module cells which are typically rectangular, rather than “pseudo-square” compared to m-Si, so they can be packed very closely in the modules. The appearance of the p-Si is distinctly blue due to the missing absorption of higher energy photons. In fact, these high energy photons from the upper part of the visible spectrum are back-reflected.

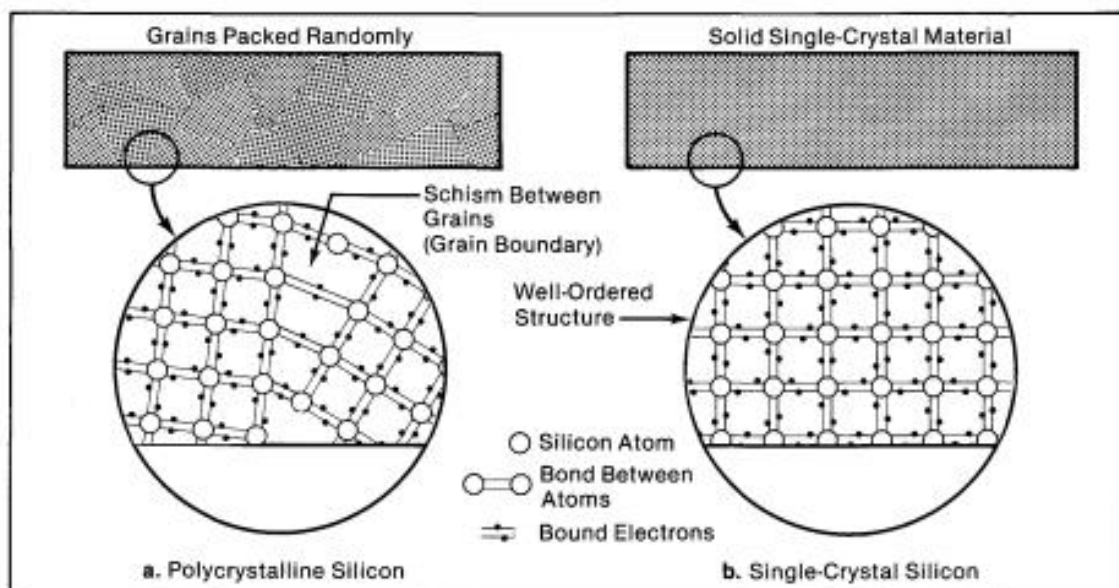

Figure 1-9: Structure of silicon crystalline. (Source: SERI, 1981)

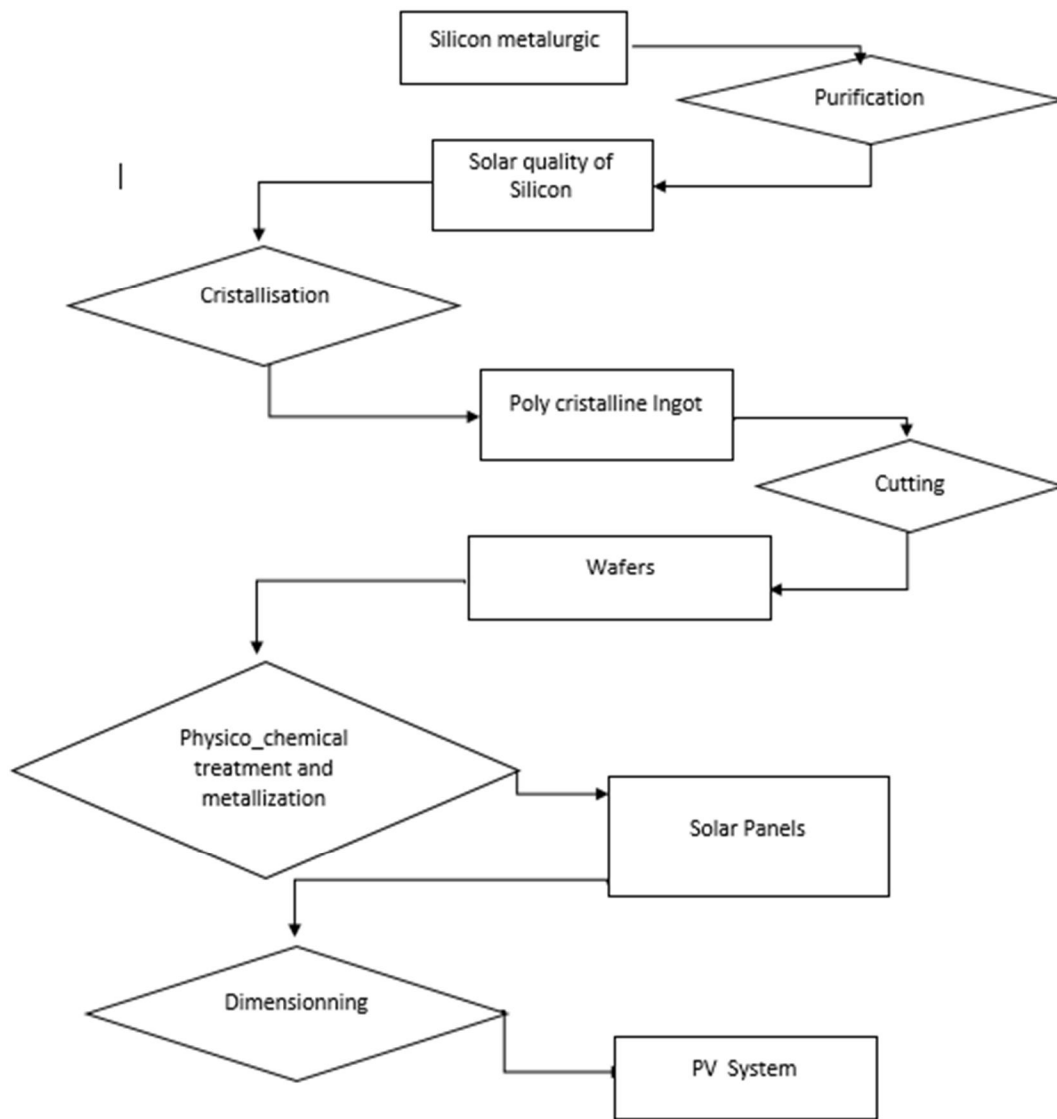

Figure 1-10: Chain of Photovoltaic Technologies of silicon crystalline (Source: Dajuma, 2015)

### 1.3.6. Electrical Characteristics

#### a) Current-Voltage and Power-Voltage Curves

The photovoltaic characteristics (or I–V curve) of a PV module is the important key for identifying its quality and performance as a function of varying environmental parameters (**Buresch, 1998; Marwan, 2006**). The curve indicates the characteristic parameters of the PV module at which it would work at peak efficiency. These parameters are indispensable for designing any small or large PV system. Therefore, it is of utmost importance to measure the I–V characteristics with high accuracy under natural environmental condition (**Mahmoud and Ismail, 1990**). However, in the dark, the I–V characteristics of a solar cell have an exponential characteristic similar to that of a diode (**Walker, 2001**). An ideal solar cell can be represented by a current source connected in parallel with a single diode, as shown in the equivalent circuit of **figure 1-11**. But the ideal case of solar cell is not reflecting the reality. More accuracy in the model (ideal solar cell) can be achieved by adding

series resistances. The configuration of simulated solar cell with single- diode and resistance series is shown in **figure 1-12**.

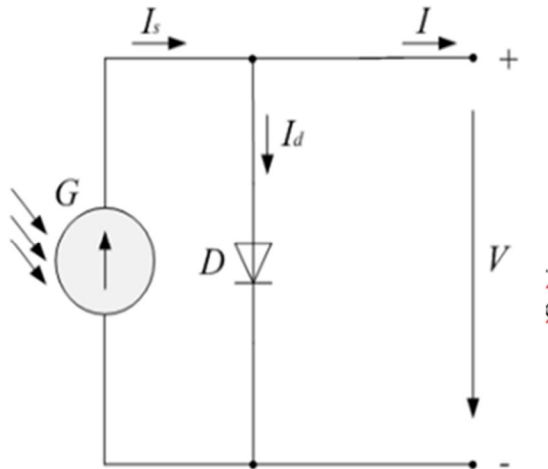

Figure 1-11: Ideal solar cell with a single diode (Source: Rodrigues et al., 2011)

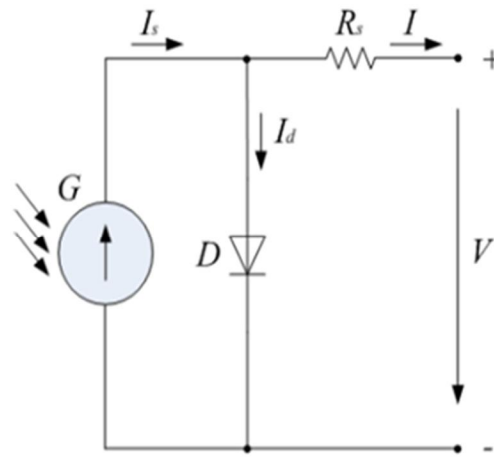

Figure 1-12: Ideal solar cell with a single diode and series resistance (Source: Rodrigues et al., 2011)

The I-V characteristics curve is given by:

$$I(V) = I_s - I_d(V) \quad (13)$$

Where:

- $I_s$  is the photogenerated current,
- $I_d$  the diode current.

The photogenerated current is generated by photon and it is proportional to the irradiance and to the cell area. Thus, we have:

$$I_s = S * G * \alpha(T) \quad (14)$$

Where:

- $S$  is the cell area,
- $G$  the incident global irradiance,
- $\alpha(T)$  a constant depending slightly to the temperature.

On the other hand, the diode current can be expressed as:

$$I_d = I_0 \left[ e^{\left(\frac{qV}{k_b T}\right)} - 1 \right] \quad (15)$$

Where:

- $q$  the electron charge, equal to  $1.602 \cdot 10^{-19} \text{ } ^\circ\text{C}$ ,

- V the voltage,
- $k_b$  the Boltzmann constant, equal to  $1.38 \cdot 10^{-23} \text{J/K}$ ,
- T the Temperature,
- $I_0$  is the saturation current. It is also known as leakage or diffusion current. For good solar cells,  $I_0 \approx 10^{-8} \text{A/m}^2$  (Tiwari, 2002).

With **equations (14)** and **(15)**, **equation (13)** becomes:

$$I = S * G * \alpha(T) - I_0 \left[ e^{\left(\frac{qV}{k_b T}\right)} - 1 \right] \quad (16)$$

At  $V=0$ , **equation (16)** gives the short circuit current ( $I_{sc}$ ), which is:

$$I(V = 0) = I_{sc} = S * G * \alpha(T) \quad (17)$$

When  $I=0$ , we obtain the open circuit voltage ( $V_{oc}$ ) from **equation (15)** and **(13)**, expressed as:

$$V_{oc} = \frac{k_b T}{q} \ln \left( \frac{I_{sc}}{I_0} + 1 \right) \quad (18)$$

From this equation, we can draw the saturation current as it follows:

$$I_0 = \frac{I_{sc}}{e^{\left(\frac{qV_{oc}}{k_b T}\right)} - 1} \quad (19)$$

In the other hand, the dependence of saturation current on temperature is given by:

$$I_0 = A_0 T^3 e^{\left(\frac{-E_g}{k_b T}\right)} \quad (20)$$

Where:

- $A_0$  is the non-ideality factor, generally taken to 1 (Tiwari, 2002);
- $E_g$  is the band gap of the material, generally taken to 1.11 eV (Tiwari, 2002), for the silicon cell (according to some sources 1.7 to 1.8 eV, Roger, 1993).

## b) Efficiency

The efficiency of a cell,  $\eta$ , can be expressed as:

$$\eta = \frac{V_m I_m}{GS} = \frac{V_m I_m}{V_{oc} I_{sc}} \times \frac{V_{oc} I_{sc}}{GS} \quad (21)$$

Where:

- $V_m$  is maximum output voltage,

- $I_m$  the maximum output current.

Given that, the fill factor, FF, is defined as the ratio between nominal and maximum power standard:

$$FF = \frac{V_m I_m}{V_{oc} I_{sc}} \quad (22)$$

It is an important indicator of PV performance

So, **equation (21)**, becomes:

$$\eta = FF \times \frac{V_{oc} I_{sc}}{GS} \quad (23)$$

Combining **equations (23) and (17)**, we have:

$$\eta = \alpha FF V_{oc} \quad (24)$$

The typical factors of form for various photovoltaic technologies are the following:

- Crystalline silicon (m-Si): FF = 0.83
- Amorphous silicon (a-Si): FF = 0.7
- Cadmium Tellurium (CdTe): FF = 0.76
- Copper Indium Selenium (CuInSe<sub>2</sub>): FF = 0.78

### 1.3.7. Photovoltaic Systems

When the light strikes on PV panels, they produce continuous electric current. This energy can be stocked in a battery. Then it goes from the battery (or directly from the PV panels) to an inverter where it is converted into alternative current depending on the end use (AC load or DC load).

When solar PV cells are connected in series, they are called solar modules. A module typically contains 28 to 36 cells in series, to generate a dc output voltage of 12 volts (V) in standard illumination conditions. The 12 volts (V) modules can be used singly or connected in parallel and series into an array with a larger current and voltage. (**Figure 1-13**).

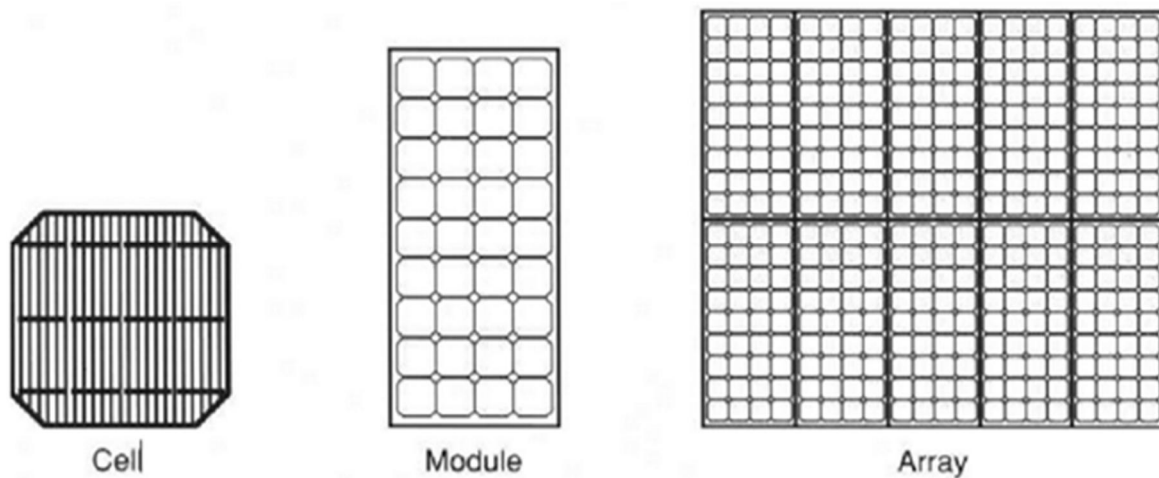

Figure 1-13: Cell, module, and array of solar PV (Source: Gary et al., 1995)

PV modules are associated with many components which constitute the so-called PV systems. Among components, we have regulators, batteries, converters or Invertors and AC/DC load (**Figure 1-14**).

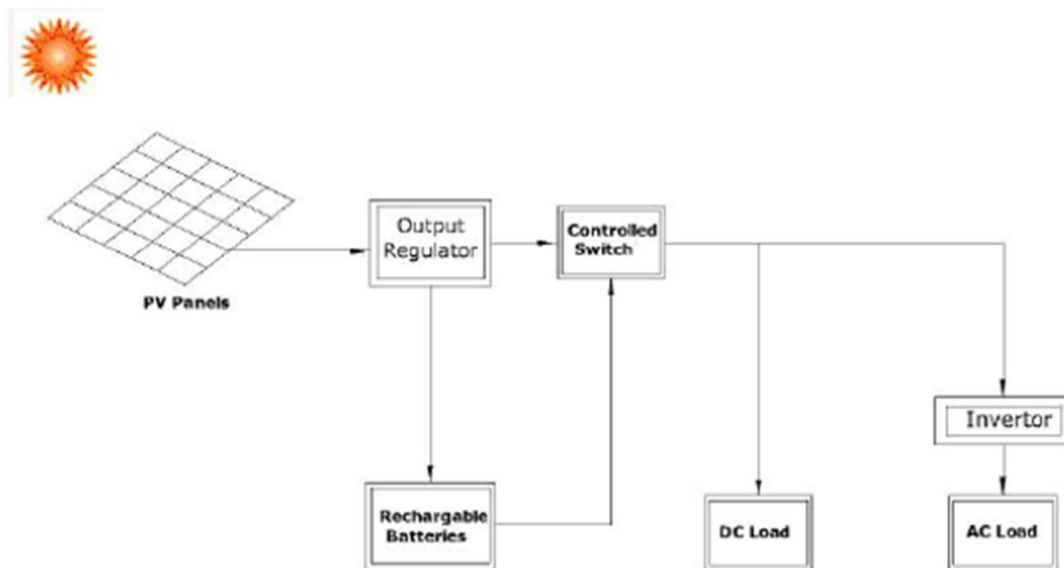

Figure 1-14: Components of a PV system (Abdelkader et al., 2010).

#### a) PV Panel

It is a generator of direct current. The most common technologies are the monocrystalline, the polycrystalline and the amorphous silicon type (**Table 1-2**).

Table 1-2: Technical characteristics of PV Module types (Source: Brigand, 2011)

Technologies	Lifetime (years)	Yield (%)
Monocrystalline	> 25	12 - 20
Polycrystalline	15 - 20	11 - 15
Amorphous	15 - 20	5 - 9

There are three (3) types of PV systems which are fixed, adjustable and tracking systems.

- **Fixed PV arrays:** the simplest and least expensive type of solar panel mounting system, it will be completely stationary. They are generally mounted on the roof of the house. These solar panels should always face the equator due south in the northern hemisphere.
- **Adjustable Panel mounting:** They are mounted at an inclined angle. The angle of inclination (tilt) of an adjustable solar panel mount can be changed 2 or more times during the year to account for the lower angle of the sun in winter as the earth orbits the sun causing seasonal change.
- **Tracking systems:** They follow the path of the sun during the day to maximize the solar radiation that the solar panels receive. A single axis tracker tracks the sun east to west and a two-axis tracker tracks the daily east to west movement of the sun and the seasonal declination movement of the sun. They are the most efficient types of solar panel mounts.

#### b) Charge Controller (Charge Regulator, Converter)

The charge regulator ensures the optimization of the electricity production of PV panels. Its role is to protect the batteries against deep discharge, then to limit the terminal charge (protection against the overcharges).

In a solar energy array, a converter is an electrical device that adjusts direct current (DC) voltage output either up or down from the input level. Often called charge controllers, these DC-to-DC converters can maximize the energy harvest for photovoltaic systems and help regulate the amount of DC energy running through the system. This means that everything in the system beyond the controller —battery banks, inverters, and the like — receive a more consistent current.

There are two main types of charge controllers:

- **Pulse Width Modulation (PWM) Controller:** This type of device is basically a switch that connects a solar array to a battery. While functional, these devices aren't particularly complex; they don't adjust for greater efficiency during more or less sunny times of day, for instance.



- **Maximum Power Point Tracking (MPPT) Controller:** MPPT controllers are much more sophisticated in function. They can adjust their energy intake, helping to increase overall output efficiency for your solar array.

### c) Battery

They store the electrical power in the form of a chemical reaction. Without storage, you would only have power when the sun was shining or the generator was running. The batteries guarantee the energy supply continuously, by stocking the energy. They should be resistant to repetitive cycles; it means that to support long charges in the day and discharges in the night, have a good yield of charge, even for the weak charges of current.

### d) Inverter

A **solar inverter**, or **converter** (See **Section c) Battery**) or **PV inverter**, converts the variable direct current (DC) output of a photovoltaic (PV) solar panel into a utility frequency alternating current (AC) that can be fed into a commercial electrical grid or used by a local, off-grid electrical network. It is a critical balance of system (BOS)–component in a photovoltaic system, allowing the use of ordinary AC–powered equipment. Solar power inverters have special functions adapted for use with photovoltaic arrays, including maximum power point tracking and anti-islanding protection.

There are also wires cables necessary to connect components together and surge arrestors acting like “clamps” in most cases. They go across the live wires with another wire going to ground. In fact, lightning strikes can cause great damage to your solar power system and can be mitigated using surge arrestors in the design loop.

Solar inverters may be classified into three (3) broad types.

- **Stand-alone inverters**, used in isolated systems where the inverter draws its DC energy from batteries charged by photovoltaic arrays. Many stand-alone inverters also incorporate integral battery chargers to replenish the battery from an AC source, when available. Normally these do not interface in any way with the utility grid, and as such, are not required to have anti-islanding protection.
- **Grid-tie inverters**, which match phase with a utility-supplied sine wave. Grid-tie inverters are designed to shut down automatically upon loss of utility supply, for safety reasons. They do not provide backup power during utility outages.
- **Battery backup inverters** are special inverters which are designed to draw energy from a battery, manage the battery charge via an onboard charger, and export excess energy to the utility grid. These inverters are capable of supplying AC energy to selected loads during a utility outage and are required to have anti-islanding protection.

Conversion efficiency for state-of-the-art solar converters reached more than 98% (**Fraunhofer ISE, 2014**). While string inverters are used in residential to medium-sized commercial PV systems,



central inverters cover the large commercial and utility-scale market while the micro-inverters are of the module power range). **Table 1-3** reports about their energy ratio range.

*Table 1-3: Range of energy efficiency of inverters (Source: Fraunhofer ISE, 2014)*

Type	Power	Efficiency
String inverter	Up to 100 kW <sub>p</sub>	98 %
Central inverter	Above 100 kW <sub>p</sub>	99 %
Micro-inverter	Module power range	90 - 95 %

### e) Solar Pumping Inverter

Advanced solar pumping inverters convert DC voltage from the solar array into AC voltage to drive submersible pumps directly without the need for batteries or other energy storage devices. By utilizing MPPT (maximum power point tracking), solar pumping inverters regulate output frequency to control the speed of the pumps in order to save the pump motor from damage.

Solar pumping inverters usually have multiple ports to allow the input of DC current generated by PV arrays, one port to allow the output of AC voltage and a further port for input from a water-level sensor.

### 1.3.8. PV System Dimensioning

It requires a precise analysis of the needs in electricity and the several factors influencing the yield (meteorological environmental data conditions, tilt angle). Its objective is to determine the technical and economical optimum between the crest power of the PV field and the capacity of the associated batteries on one hand from the electrical needs of the user and the solar radiation data of the place, and on the other hand, from the price and the quality of the components available on the market. The method is based on the concept of error probability in the consumption (ratio between the deficit and the demand for energy). It consists in the realization of the energy balance every day for several years to calculate the dimensions of the modules and batteries which will guarantee a reliable data on the consumption. Its advantage is that it energetically optimizes the installation. Its principal disadvantage is that we have to know the monthly solar radiation of the site for some years (10 to 20), which is not easy to obtain. In most of the case, we used the irradiance of the less favorable month. The criteria of dimensioning for a stand-alone, a hybrid or grid-connected PV system are quite the same.

- For a stand-alone, we should find the best compromise between the need for electricity and the investment cost.
- For a hybrid installation, the dimensioning consists of producing the energy as much as possible according to the available surface and the investment capacity of the foreman.

The following example refers to the case of stand-alone PV systems. There are roughly seven (7) steps in the dimensioning of a PV system:

- (i) Calculation of the daily energy need;
- (ii) Choice of the Nominal Voltage;
- (iii) Choice of the Inverter;
- (iv) Estimation of the Capacity of the Batteries;
- (v) Calculate the crest installed power;
- (vi) Choice of the charge controller;
- (vii) Choice of the cables.

#### a) Calculation of the Daily Energy Need

One should do an inventory of the electrical characteristics of the receiver (power, voltage), the duration of their functioning during the day, elaborate an estimated balance of the power needed by your receiver. The daily energy need,  $E_d$ , is expressed as:

$$E_d = \sum_{i=1}^n P_i t_i \quad (25)$$

Where:

- $P_i$  is the  $i^{\text{th}}$  receiver's power;
- $t_i$  is the  $i^{\text{th}}$  receiver's duration of functioning of the loads in the day.

#### b) Choice of the Nominal Voltage

You can then deduce the number of PV power that is needed to supply your receiver. For a given range of PV power, there is a recommended nominal voltage. **Table 1-4** presents the nominal voltage recommended according to the power.

Table 1-4: Generator voltage in function of power (Source: Brigand, 2011)

PV Power	0 – 0.5 kW <sub>p</sub>	0.5 – 2 kW <sub>p</sub>	2 – 10 kW <sub>p</sub>
Recommended voltage	12 V	24 V	48 V

#### c) Choice of the Inverter

The principal characteristic of an inverter is its nominal power,  $P_{inv}$ , such as:

$$P_{inv} \geq kP_{AC} \quad (26)$$

Where:

- $k$  is a factor comprised between 2 and 3 taking into account the current take-off at the starting of the appliances;
- $P_{AC}$  is the receiver's power functioning in alternative current.

However, the DC voltage should match with the nominal voltage of the generator (See Section **b** below).

#### d) Estimation of the Capacity of the Batteries

The necessary data for determining the capacity of the battery in addition to the daily energetic need ( $E_d$ ) is given below. One should check out:

- the efficiency of the battery ( $\eta_{bat}$ ) (typically 85%);
- the nominal voltage of the battery ( $V_{bat}$ ) which is equaled to the nominal voltage of the PV modules (12V, 24V, 48V);
- the depth of discharge (DOD) of the battery, from 50 to 80%;
- the number of autonomy days of the batteries ( $N_{aut}$ ) depending on the number maximum of days there is no sunlight.

The capacity of the battery is given by:

$$C_{bat} = \frac{E_d}{V_{bat}\eta_{bat}DOD} N_{aut} \quad (27)$$

#### e) Calculation of the Crest Installed Power

To calculate the crest installed power, one should calculate:

- the daily energetic need,  $E_d$ ,
- the efficiency of the battery,  $\eta_{bat}$ ,
- the number of equivalent hours ( $H_e$ ),
- the efficiency of the inverter,  $\eta_{inv}$ .

We can compute the crest installed power as it follows:

$$P_c = \frac{E_d}{H_e\eta_{inv}\eta_{bat}} \quad (28)$$

The number of equivalent hours ( $H_e$ ) is the theoretical time during which the solar radiation is maximal in the day. It is calculated from the mean irradiation of the unfavorable month in the plan of the module (See **Table 1-5**, for Niamey, Niger), as:

$$H_e = \frac{E_r}{G_c} \quad (29)$$

Where:

- $E_r$  (Wh/m<sup>2</sup>/d) is the daily solar radiation for the unfavorable month in the plan of the module;
- $G_C$  the standard solar radiation rating, taken to 1 000 W/m<sup>2</sup>.

Table 1-5: Solar radiation data of Niamey in 2015 (Source: CNES, 2015)

Month	Mean Horizontal Radiation	Mean Tilted (15°) Radiation (Wh/day)	Equivalent Hours (for tilted position)
January	5 291	5 782	5.8
February	5 820	6 214	6.2
March	5 633	5 794	5.7
April	6 315	6 200	6.2
May	5 896	5 558	5.6
June	5 677	5 272	5.3
July	5 605	5 200	5.2
August	5 127	4 897	4.9
September	5 585	5 593	5.6
October	5 735	6 074	6.1
November	5 492	5 968	6.0
December	5 113	5 594	5.6
<b>Annual</b>	<b>5 607</b>	<b>5 679</b>	<b>5.7</b>

The nominal voltage of the regulator should be equal to the nominal voltage of the PV generator. Its current capacity should be equal to the maximum current of charge from the PV panel and to the maximum current of discharge from the receivers.

#### f) Choice of Cables

More attention should be carried to the choice of cable section while linking the DC part of the installation. In fact, the energy lost, through the Joule effect, is proportional to the square of the current. The calculation of the section of the cables linking the system components depends essentially on the distance between components. According to the amount of current passing through, there is a corresponding section of cables that can support it.

### 1.4. Utilization of Solar PV in Niger: Inventory and Estimation

A recent study of the National Centre of Solar Energy (Centre National de l'Énergie Solaire – CNES in French) of Niger conducted during the year of 2014 to 2015, inventoried and estimated

Niger energies' potential either from conventional or renewable sources. Thus, Niger has a significant potential for solar energy throughout the country because of its position close to the equator, the sun passing twice to zenith per year. The average daily radiation varies from 5 to 6 kWh/m<sup>2</sup>. The average period of sunshine varies from 8 to 9 hours per day. However, despite these huge potentials, the participation of solar energy in the national energy balance is insignificant. The capacity of photovoltaic installations in Niger stood at 0.29 MWp in 1993, 1.08 MWp in 2006 and 5.2 MWp in 2014 (**figure 1-15**). The mean annual increase between the two periods of 2006 and 2014 is about 48 % (CNES, 2016).

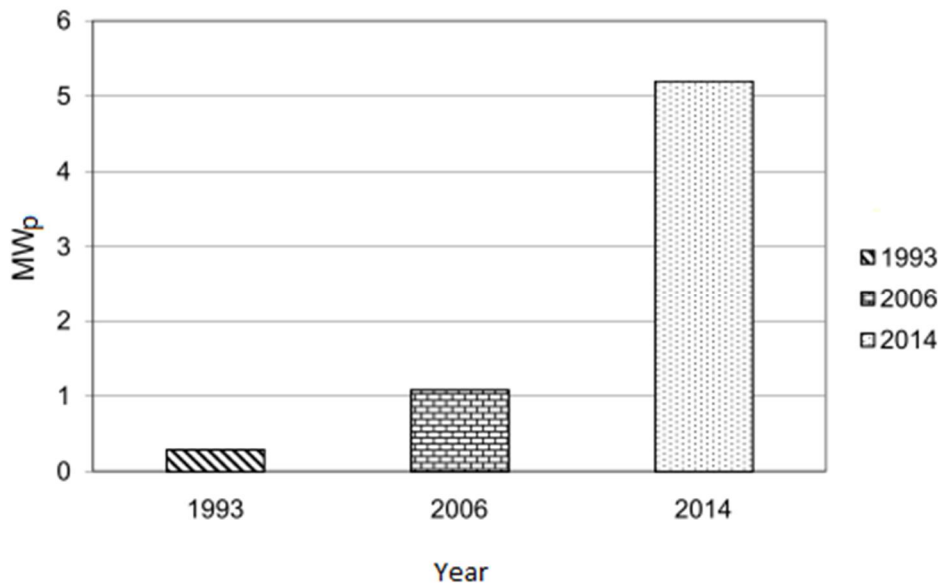

Figure 1-15: Evolution of the capacity of photovoltaic installations (Source: CNES, 2016)

#### 1.4.1. Community and commercial utilization

In Niger, only 7% of household have access to the electricity, and more than 89% of the primary energy consumed comes from traditional biomass (wood, agricultural waste), (CNES, 2016). About 76% of the population does not have access to electricity (IRENA, 2013). Niger's energy sector is highly dependent on Nigeria which provides 83% of the energy needs (CNES, 2016). Moreover, the energy sector is marked by a strong disparity between urban and rural areas (CNES, 2016). In fact, in 2005, the access rate in rural areas where more than 80% of the population lives, was 0.28%, compared to 41% in urban areas.

The following **figure 1-16** shows the repartition of PV installed capacity per application field. Telecommunication has the greatest part of the share, 39%, followed by water pumping then general electrification which shares are equaled respectively to 27% and 14%.

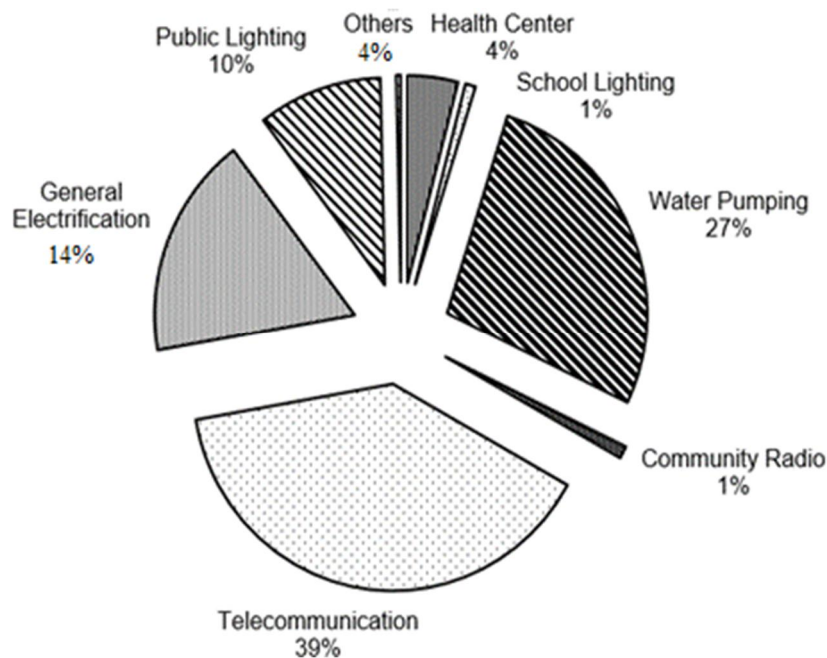

Figure 1-16: Repartition of photovoltaic installed capacity per application (Source: CNES, 2016)

Niger country is divided into eight (8) regions including Niamey the capital city. For the eight regions of the country, the greatest PV capacity installed is dominated by Dosso region with 1,174.35 kWp while Agadez has the smallest PV installed capacity of 177.42 kWp in 2014 (**figure 1-17**).

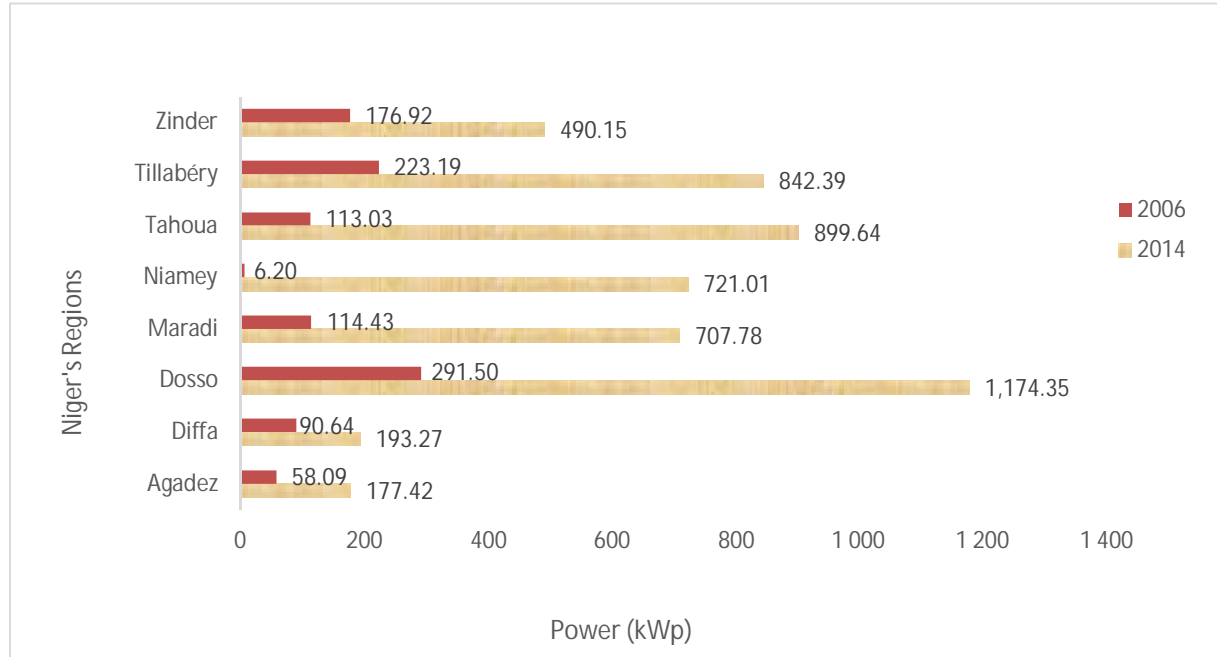

Figure 1-17: Repartition of photovoltaic installed capacity per region (Source: CNES, 2016)

Tillabéry's PV capacity installed comes at the 3<sup>rd</sup> place with 842.39 kWp where telecommunication represents 54% (**figure 1-18**) of the PV power supply.

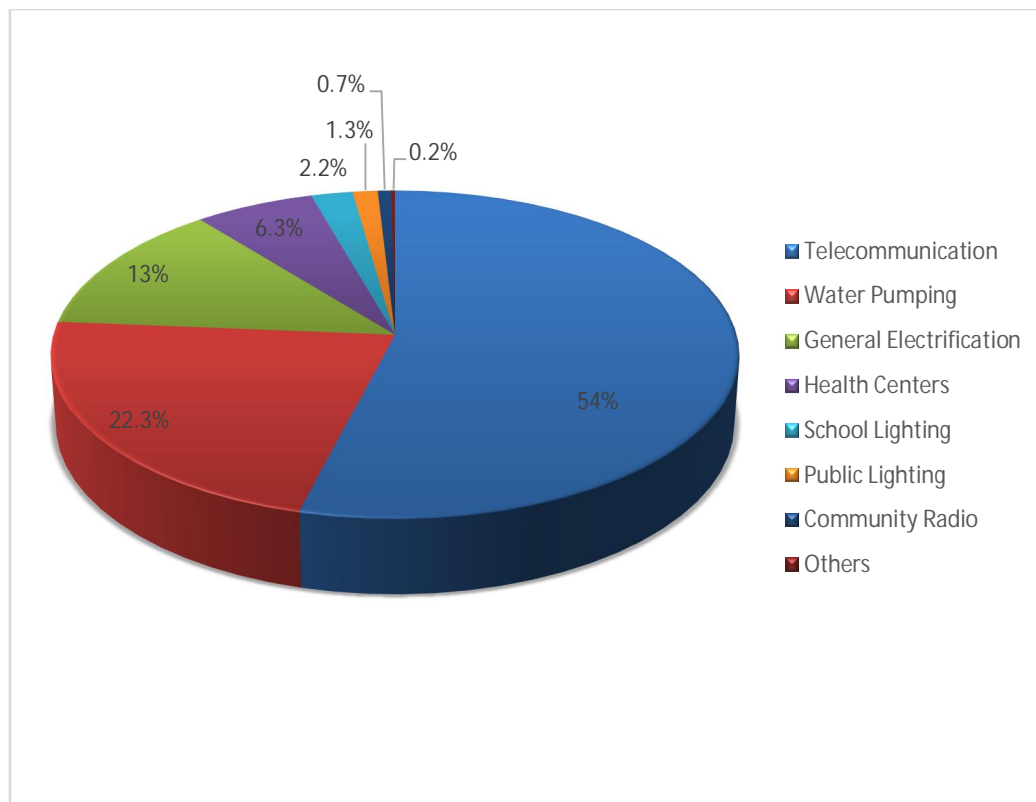

Figure 1-18: PV market in Tillabéry, Niger (Source: CNES, 2016, data from 2014 inventory and estimation)

For all Tillabéry's PV capacity installed, only 7.52 kWp in telecom towers field (CNES, 2016) have been inventoried for Kobadjé village (Torodi's Commune). However, our surveys show a huge commercial potential for solar PV systems around and within this rural area especially of Kobadjé which is still not connected to the electricity grid.

The most promising customers for PV power supply systems in Niger are the telecom companies. One hundred eighty-five (185) sites in rural areas have already been equipped with 6kWp per site by AIRTEL and it is expected that thirty (30) new sites will be equipped by the solar power each year (SNV, 2014).

#### 1.4.2. Personal utilization

In Niger, the per capita electricity consumption was less than 50 kWh in 2012 against an African average of over 575 kWh and a global average of over 2770 kWh (IRENA, 2013). This makes the average Nigerien citizen among the lowest consumers of electricity in the world.

Indeed, if other market sections such as AC and DC powered solar home systems are partially added to the telecom section, more than 60% of the photovoltaic market in Niger is a private investment without subsidies (SNV, 2014). Solar pumping projects are mainly financed by large-scale infrastructure donor grants in the hands of public customers.



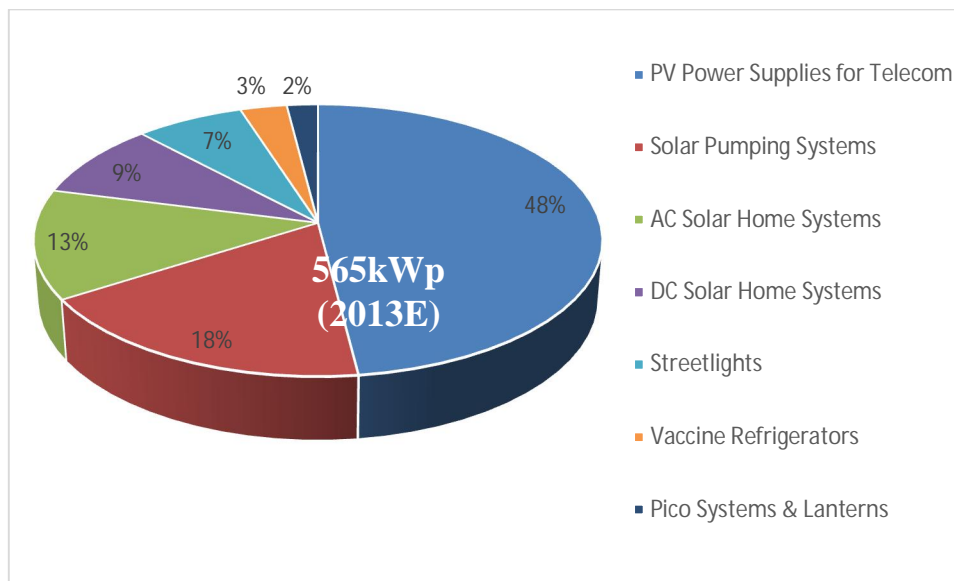

Figure 1-19: 2013 PV market in Niger (Source: RAACH SOLAR, estimations, empirical data)

Solar energy utilization covers several socioeconomic sectors through the country (**figure 1-19**). The National Association of Solar Professionals (Association Professionnelle de l'Énergie Solaire, APE-Solaire in French) comprises private companies and operators in Niger, with currently roughly 600 kWp installed (SNV, Raach Solar, 2014). This can be due to the narrowness and the instability of the national network but also the recent competitiveness of the solar sector and the product reliability.

The most popular utilization of solar equipment used by rural people is a torch with a built-in small solar module. The cost of a standard LED battery lamp is in Niger around 1000 F CFA (1.50 €). One pair of AAA MIGNON batteries is 250 F CFA. A torch owner spends around 500CFA (0.75 €) per week for lighting services (SNV, 2014).

Nevertheless, there is a growing investment interest in PV grid connection and standalone system due to the fact that the prices of the solar modules are decreasing (**Bonkaney, 2015**). A typical solar home system is a 12V direct current solar system with a 50Wp solar module, a 12V-6A charge controller, a 12V-80Ah lead-acid or lead-gel battery and four 12V-7W compact fluorescent lamps (SNV, 2014). Because the 50Wp module generates between 150Wh to maximum 300Wh per day depending on the installation site, these solar home systems also allow the connection of a 12V DC radio or 12V DC television set. The price of a DC solar home system is for many rural households not affordable without a financial down payment system.

Two (2) cases study of Bossey Bangou and Gorou Beri (villages close to the capital Niamey) carried out by SNV & RAACH SOLAR in November 2013 reveals that lighting is the major application and concern of all households (SNV, 2014). Most of the households have LED lamps (2,000 FCFA) and radios (5,000 FCFA) for entertainment which run on batteries. The owners of LED torches or lamps spend around 500 F CFA/week for mainly AAA MIGNON batteries when many people own mobile phones and charge them for 700 F CFA per week.

The future electricity demand is driven by the desire to have fans, televisions and the possibility to charge mobile phones (SNV, 2014).

## Partial Conclusion

As long as sun emits radiation on Earth, solar energy is available but according to several factors abovementioned. Thus, solar energy has emerged as a renewable, clean, reliable and free source of energy encapsulated in photovoltaic cells. Indeed, solar radiation is one of the most important parameters for PV technologies and its calculation involves many factors. PV systems are environmentally friendly and make no noise. There are several environmental and meteorological conditions but also the others parameters for instance tilted angle of PV panels and its orientation that affect PV systems functioning under real outdoor conditions.

Solar energy is free and cost effective but not least, useful for rural electrification. In Niger, energy demand has increased particularly in rural sectors. Solar energy investment in rural areas is socially and economically justified. That it is why there is a need to have a close look at why the use of solar PV technologies is socially and economically justified.

## **Chapter II: TECHNICAL PERFORMANCES AND USE OF PHOTOVOLTAIC SYSTEM IN SCIENTIFIC LITERATURE**

## Introduction

PV systems operate under certain weather conditions. However, since the weather is always changing and as solar panels are still being installed all over the world in different climate regions, it becomes indispensable that researchers and engineers carry on understanding how PV panels react to different weather conditions: effects of dust, humidity, wind speed, ambient and cell temperature. Not only weather conditions have to be taken into account but also the effects of irradiance (the most important PV panels input) and the orientation and the tilted angle at which PV panels should operate at the optimum. In sum, it is to adapt ideal solar panel types for different weather conditions and locations.

Indeed, it is well known that PV technologies are used either in urban or rural areas in order to compensate energy demand which is increasing. Energy services implementation in rural areas is experiencing a major evolution during this last decade. To date, the ability to pay for energy services of the rural population is carrying on improving, allowing to rural population to take advantage of the electricity from PV panels, economically and socially.

This chapter presents in one hand, parameters affecting solar panels performances under real conditions, and another hand, the socioeconomic impacts of the utilization of PV systems in the literature.

### 2.1. Parameters Affecting Solar Panels Performances

#### 2.1.1. Effect of Dust

There are different studies (**Nimmo and Said, 1981; Mani and Pillai, 2010; Sayigh, Al-Jandal and Ahmed 1985; Touati, Al-Hitmi and Bouchech 2013**) conducted to investigate the effect of dust on solar cells where a wide range of performance reduction was reported. **Figure 2-1** reports on the presence of dust in the Niger atmospheric through the climatic visibility variation. As regarding the impact of dust on PV panel whether dust accumulation will take place to such a degree that the PV panels' output would be significantly reduced is entirely dependent on the climate. Dust is defined as a minuscule solid particle less than 500 $\mu\text{m}$  in diameter (Reference to Sahel dust's composition). In the normal conditions, the fine dust is glued to the surface of the module and provokes a reduction of performances (**A. Benatiallah et al., 2012**). Dust density produces a reduction in performances of the solar module. Also, the dust decreases the illumination flux which itself lead to a decrease of the power. Therefore, the exploitation of the solar energy to satisfy the energy demand in Sahara areas is limited by the effect of dust on the performances of the photovoltaic generator (**A. Benatiallah et al., 2012**). Thus, in dusty climates like Sahel regions (**Figure 2-1**), regular cleaning, more frequently, is needed to maintain the PV panels' output and efficiency. Even in absence of winds, the characteristics of the module are influenced by the thin grain suspended on the surface leading to a decrease of the power and the efficiency.

**Mazumder et al. in 2002**, analyzed the dust deposition mechanisms on a solar module, the conclusions they deduced that the reduction in solar modules performance depends on the particle

size, shape, distribution, deposition mechanisms and orientation of dust deposits on the module (**Z. A. Darwish et al., 2013**).

Dust accumulation on PV system on the surface of the solar module causes decreasing in the performance about 35-65% for one month accumulated time under Iraqi weathers. In the dry weather, the adhesive force between the dust atoms and the glass cover of the solar module is the only reason for dust deposition, while, there are many layers of dust arise on the solar module surface in weather with high humidity (**A. H. S. Al-Sudany, 2009**).

According to some studies (**Mani and Pillai, 2010; Kaldellis and Kapsali 2011**), the surface, tilt angle, humidity and wind speed also affect the dust settlement.

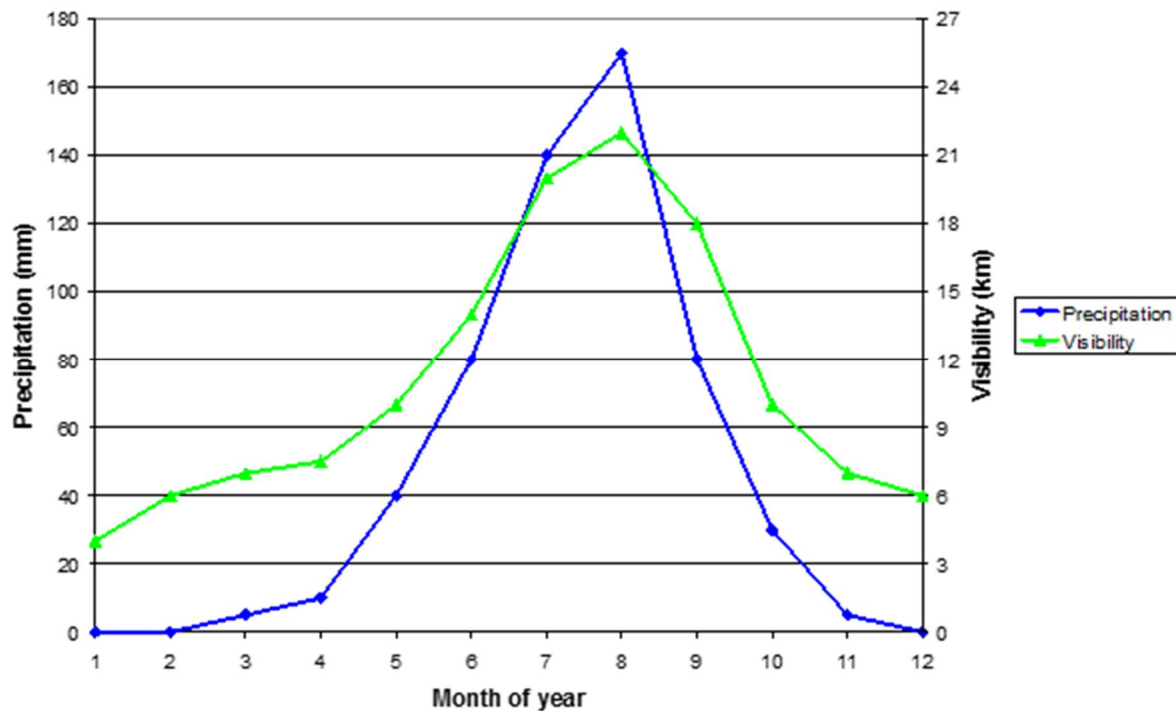

Figure 2-1: Climatic conditions: Annual curves of horizontal visibility and precipitation. (Source: After Frangi et al., 1992)

### 2.1.2. Effect of Orientation and Tilted Angle on PV Panels

A tilt angle is one of the important factors that determine the performance of PV panels. A good orientation and tilt angle of PV module can maximize its energy potential. In most of the solar energy applications, inclined surfaces at different angles are widely employed (**Samy A. Khalil and A. M. Shaffie, 2013**). Because the angle of incidence of the sun varies over the course of the year, the maximum radiation yield can be obtained only if the receiving surface is inclined at an angle to the horizontal (**Earthscan, 2010**). The optimum angle of inclination is larger in the low-radiation months than in the summer because of the low elevation of the sun. For the best performance of your systems in the year, in most locations, fixed PV modules should be oriented to the true south (in the Northern Hemisphere) (**Dajuma et al., 2016**).

### 2.1.3. Effect of Temperature PV Cell ( $T_{NOCT}$ )

Solar cell performance decreases with increasing temperature (**Swapnil Dubey, Jatin Narotam Sarvaiya and Bharath Seshadri, 2013**). The operating temperature plays a key role in the photovoltaic conversion process. Both the electrical efficiency and the power output of a PV module depend linearly on the operating temperature. The change in temperature will affect the power output from the cells. The voltage is highly dependent on the temperature and an increase in temperature will decrease the voltage (**figure 2-2**). However, certain types of modules are more resilient to temperature increases than others, as it will be seen in this study. In the same vein, heat has an effect on panel degradation. Consequently, long-term exposure to heat will damage the panel more rapidly, some materials may not be even able to withstand short peak of very high temperature (**Kurtz et al., 2009**).

Temperature affects how electricity flows through an electrical circuit by changing the speed at which the electrons move (**Dajuma et al., 2016**). This is due to an increased resistance of the circuit resulting from the rise in temperature. Therefore, resistance decreases with decreasing temperatures.

In the standard approach (**C. Schwingshackl et al., 2013**), the cell temperature is calculated according to:

$$T_c = T_a + \frac{I}{I_{NOCT}} (T_{NOCT} - T_{a,NOCT}) \quad (30)$$

- $T_a$  is the ambient temperature;
- $I$  is the in-plane irradiance;
- $T_{NOCT}$  is the technology dependent nominal operating cell temperature, which is the cell temperature at irradiance at  $I_{NOCT} = 800 \text{ W/m}^2$ ;
- $T_{a,NOCT}$  is ambient temperature,  $T_{a,NOCT} = 20^\circ\text{C}$  and wind speed 1 m/s.
- $T_{NOCT}$  depends on the PV technology and has a typical value of about  $45^\circ\text{C}$ .

Solar cells vary under temperature changes (**V. Jafari Fesharaki, Majid Dehghani, J. Jafari Fesharaki, 2011**). The concept of temperature coefficient ( $T_C$ ) is useful to quantify the temperature sensitivities of the performances of photovoltaic (PV) devices (**O. Dupré et al., 2017**). However, in order to compare different technologies,  $T_C$ s are defined normalized at  $25^\circ\text{C}$  ( $298.15 \text{ K}$ ) (**K. Emery et al., 1996**).

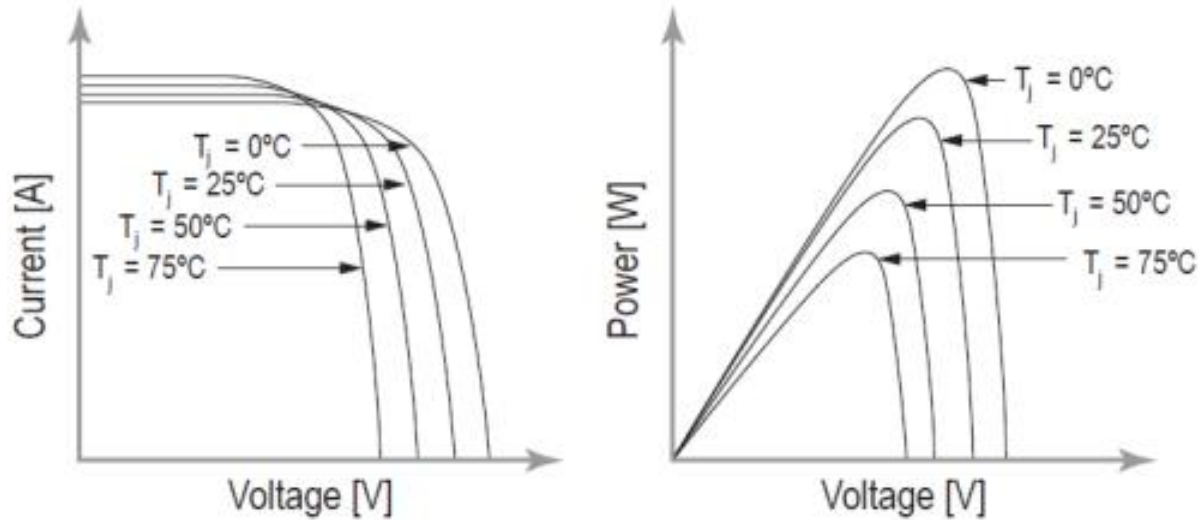

Figure 2-2: Temperature effect on the PV characteristics (Gueymard, 2009)

#### 2.1.4. Effect of Shading, Ambient Temperature, Irradiance, Wind Speed and Humidity on PV Cell Performance

##### a) Shading Effect

Shading reduces the yield of a solar PV system. To take account of shading of the receiving surface by the surroundings (houses, trees etc.), three methods can be used: graphical method (indicative), photographic method (indicative) and computer-aided method.

##### b) Ambient Temperature Effect

PV solar panels must be installed at a place where they receive more air currents so that the temperature remains low while the output remains high (Ike, 2014). Indeed, the application of photovoltaic technology in the conversion of solar energy to electricity is not favorable during the period of very high ambient temperature than the period of low ambient temperature. The **table 2-1** below shows different temperatures between PV silicon technology.



Table 2-6: Ambient Temperature Variation according to the PV technology (Source: A. A. Hossam-Eldin, C.F. Gabra and Ahmed Hamza H. Ali, 2014)

Comparison between efficiencies of the three (3) types of solar panels at different temperatures			
Temperature (Ambient)	Monocrystalline efficiency	Polycrystalline efficiency	Amorphous efficiency
25°C	15%	14%	10.36%
30°C	13%	12%	9.6%
35°C	12.8%	11%	9%
37°C	11%	10.2%	8.3%
40°C	9.9%	9.2%	7.9%
45°C	7.65%	7.5%	7.46%

### c) Irradiance Effect

Many previous studies (Biicher, 1997; Paretta et al., 1998; Schumann, 2009; Suzuki et al., 2002; Zinsser et al., 2009) have shown that at low irradiance levels, there is a decrease in efficiency and performance that also depends on the technology.

According to Alonso Garcíá and Balenzategui in 2004 and Diaf et al., in 2008, solar irradiance has the greatest impact on the power output of a PV system (figure 2-3).

The PV modules are rated at standard condition of  $1000\text{W}/\text{m}^2$  of irradiance (Perraki and Tsoikas, 2013).

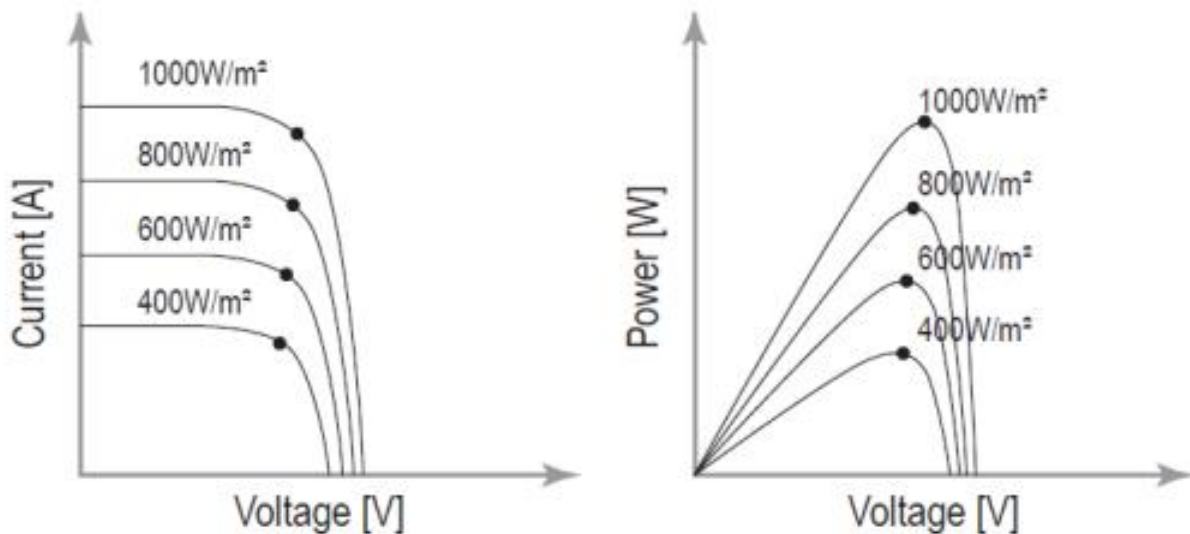

Figure 2-3: Irradiance effect on the PV characteristics (Gueymard, 2009)

#### d) Wind Velocity Effect

When the air velocity increases, the cell temperature will drop and better PV cell efficiency will result. However, The PV modules are rated at standard condition of 1 m/s wind speed (**Perraki and Tsolkas, 2013**).

#### e) Humidity Effect

In analyzing the effect of humidity, two scenarios need to be considered (**S. Mekhilef, R. Saidur and M. Kamalisarvestani 2012**). The first scenario is the effect of water vapor particles on the irradiance level of sunlight and the second scenario is humidity ingress to the solar cell enclosure. In the first scenario, it has been concluded that humidity alters the irradiance non-linearly and degrades  $I_{sc}$  but has an insignificant effect on  $V_{oc}$  when the power output, efficiency drops. However, in the second approach; when PV cells are exposed to humidity for the long term there will be some degradation in performance. It has been observed that the high content of water vapor in the air causes encapsulant delamination.

**Hussein A. Kazem et al., in 2012**, observed indirect proportionality between PV performance and humidity by studying three (3) PV types (p-Si, m-Si, A-Si) in Oman. The results showed that the output current, voltage, and power increase with low relative humidity. The efficiency of the PV is high when the humidity low. Hence low relative humidity enhances the performance of PV systems (**Hussein A. Kazem et al., 2012**).

Humidity drastically affects the performance of Solar Panels and proves out to decrease the power produced from the Solar Panels up to 15-30% if subjected to an environment where in the humidity level remains high (**Manoj Kumar Panjwani and Dr. Ghous Bukshsh Narejo, 2014**). Humidity causes more dust coagulation (**S. Mekhilef, R. Saidur and M. Kamalisarvestani 2012**).

## 2.2. PV Energy Storage System Performances

The use of energy storage devices with PV systems is currently receiving a lot of attention, especially due to the fact that the power generated from these systems is intermittent (**Oman Walid, 2010**). The installation of storage devices like batteries can enhance the performance of PV systems by bridging their power fluctuations, shifting the time of their peak generation, supplying critical loads during power outages, and providing reactive power support (**Oman Walid, 2010**). Indeed, batteries are charged and discharged by a reversible chemical reaction between the two liquid electrolytes of the battery. Usually, the battery operates during the period of high generation of the PV system, around noon.

## 2.3. PV Pumping System Performances

In photovoltaic (PV) water pumping, diurnal insolation variability, nonlinear efficiencies, and sensitivity of system performance to the well pumping head and the PV array size all affect system performance (**Odeh, 2013**). According to a study of **Wagdy R. Anis and Hamid M. B. Metwally**

in 1994, there are overshoots of both current and voltage of the DC motor of a directly coupled Photovoltaic (PV) pumping systems. The efficiency of a directly coupled PV water pumping system can increase by carefully selecting the size of the array, its orientation and motor–pump system (A. Mokeddem et al., 2011). Thus, this kind of system is a low-cost design and operates without battery. The figure 2-4 represents the PV pump curve where the pump system was monitored under different climatic conditions and varying solar irradiance with two static head hydraulic system configurations.

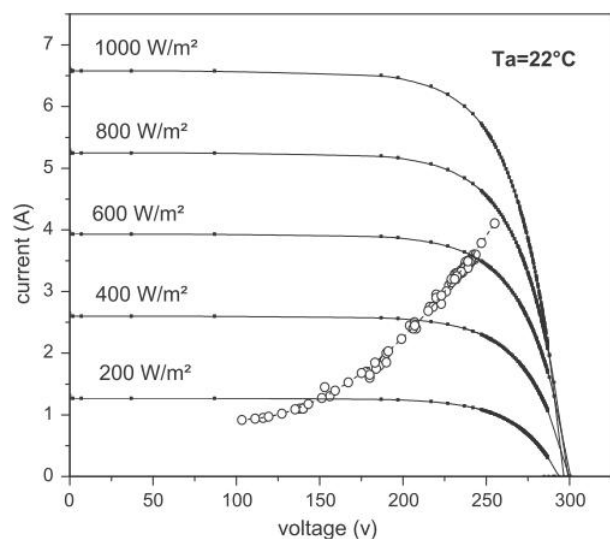

Figure 2-4: PV pumping system performance curve (Source: A. Mokeddem et al., 2011)

The performance of PV water pump mainly depends on the water flow rate which is influenced by weather conditions at the location, especially solar irradiance and air temperature variations. The performance of solar pump depends on the water requirement, size of water storage tank, head (m) by which water has to be lifted, water to be pumped ( $m^3$ ), PV array virtual energy (kWh), energy at pump (kWh), unused PV energy (kWh), pump efficiency (%), and system efficiency (%) and diurnal variation in pump pressure due to change in irradiance and pressure compensation. (Foster R, Majid G, Cota A., 2014)

## 2.4. Use of PV system

### 2.4.1. PV Market in Rural Areas

The purpose of rural electrification is to provide people with modern energy services and to improve the socio-economic situation of the rural people. This leads to enhanced quality of life, reformed education and increased economic activity, as well as improved health and increased agricultural productivity (Urmee et al., 2016). In most emerging markets, sunlight is an abundant resource and as a result PV technology is a cost-effective option (BMZ, 2016). However, the rural population is usually poorer than the urban population (Carl-Anton von Heyking, Tinoush Jamali Jaghdani, 2017). Furthermore, high transaction costs and the subsidies for conventional fossils, as well as non-renewable energies, complicate the electrification. Market development barriers are the next challenge.

According to some estimates, in rural areas those earning USD 1.25 per day may spend as much as USD 0.40 per day for energy (IEA, 2011). Rural electrification is expected to represent the bulk of the installed capacities in many developing countries, but available information is scarce. At the end of 2009 capacities were estimated at 22 MW for Bangladesh, 10 MW for Indonesia, 7 MW (each) for Ethiopia, Kenya and Nigeria, and 5 MW (each) for Senegal and Sri Lanka (IEA, 2011). Each megawatt of solar home systems with an average size of 50 W offers basic solar electricity to 20,000 households, but these numbers pale when compared to the considerable demand in the developing world. As solar electricity costs go down, these markets will open further.

#### 2.4.2. Socioeconomics Impacts of Solar PV Energy Use

It is interesting to notice that there are areas in Africa where solar potential can be considered very interesting, with the same photovoltaic panel ready to produce twice as much electricity in Africa as in Central Europe on average (S Szabó et al., 2011). Nevertheless, to be considered as a suitable energy solution for providing electricity to rural areas, photovoltaic has to prove to be more economically convenient once compared with at least two main competitors, grid extension and traditional diesel generators (S Szabó et al., 2011). In certain cases, grid extension may prove to be the most economical solution to bring electric power to rural communities. Indeed, a mini-grid or a stand-alone system could be the least-cost option, especially given the overall underdevelopment of the grid infrastructure and the excessive cost of grid building when the expected electricity load is relatively low. In such a situation, mini-grids based on local renewable resources may prove to be more affordable in specific regions than grid extension. It is also relevant that some of the renewable energy technologies (e.g. PV itself) are much more productive in Africa than in regions where renewable energies are highly present in the national energy mix. Socio-economic benefits are gaining prominence as a key driver for renewable energy deployment (IRENA, 2014). Mini-grid based rural electrification, such as street lighting, solar kiosks, mobile-phone charging stations, telecom towers and pumping water, has been implemented in many African countries offering a cost-effective alternative (IRENA, 2015).

Indeed, lack or limited access to modern energy services could hamper economic growth and compromise the development prospects of African countries (Nadia S. Ouedrago, 2012) especially when rural electrifications levels are routinely below 5% in Sub-Saharan Africa (Stephen Karekezi and Waeni Kithyoma, 2002). At the household level, electricity from PV has little impact on cooking in rural households, which is the highest end use of household energy (Stephen Karekezi and Waeni Kithyoma, 2002). PV technology, therefore, does not reduce inefficient biomass energy use in rural households, which affects the health of women and children.

Solar PV is promoted in rural areas to meet household lighting needs where kerosene is still the most widely used modern energy source for lighting (Stephen Karekezi and Waeni Kithyoma, 2002). Nevertheless, Pico PV Systems (PPS) and SHS are remarkably often within the payment capacity of most rural people in developing countries and offer immediate, affordable solutions to communities (VILAR, 2012).

According to **S.A. Khan et al. in 2014**, a combination of qualitative and quantitative methodological tactics was used to provide descriptive evidence concerning electricity's impact on the assessable socio-economic data. Thus, they showed that SHS's contribute to sustainable development by improving social aspects of rural life mainly. In fact, the implementation of SHS's in rural Bangladesh causes optimistic impacts in the areas of education, health, information, communication, social security and household works. Moreover, the plummeting of CO<sub>2</sub> emissions through the substitution of traditional lighting fuels represents a positive environmental impact. The economic impacts of the SHS's are limited to an increase in income of shops.

Solar home systems (SHS) typically generate 12V or 24V direct current and can power small electric appliances compact fluorescent lights, radios, TV sets and mobile phone rechargers and small refrigerators (**Jan Rordorf, 2011**).

A case study of solar electrification in a rural area (**Dominic Fong, 2014**), revealed that villagers can effortlessly extract clean ground water. The lighting system installed in the village offers a proper lighting which enhances within community safety, as well as the residents' productivity during nighttime. Furthermore, the electrification of the local clinic allows medicine refrigeration, and therefore greatly expand clinic's effectiveness. Electricity from solar energy systems has brought information, education, entertainment to the community but also enabled them to communicate (possibility to have more phones).

## Partial Conclusion

It is relevant to record the performance of PV panels under real climate condition which can be affected by solar radiation and other environmental and meteorological parameters such as wind speed, humidity, dust, and temperature. Nevertheless, the angle at which a PV module is tilted influence the power output of a PV system too. Accordingly, it becomes essential for researchers and engineers to carry on improving PV technologies efficiency by taking into account also the location, either in urban or rural areas. Nowadays, for several countries, any electrical generation system should be at everybody's level, especially in remote and/or rural areas. And solar energy becomes more and more one of the solutions.

As solar PV systems become more common, PV technologies are considered also cost-effective and reliable. In rural areas, there are many ways in which the use of PV panels can help in boosting the local economy. Rural areas which are using PV systems to power buildings or to run businesses can enjoy a cleaner quality of air (pollution free) contrary when kerosene, woods or others fuels are used. Hence, it can also reduce the oil dependence and the costs of electricity (low electric bills). Also, PV panel is used to power water pumps and communication equipment widely in rural and remote areas from which money can be saved. Furthermore, PV panels are well-thought-out and well-suited for small electronics appliances.

Considering all these facts, it proves to be necessary to carry on improving deeply solar PV technologies in terms of PV efficiency, cost, and cost-effectiveness.

## **Chapter III: MATERIALS AND METHODS**

## Introduction

As aforementioned previously, several parameters and environmental/meteorological conditions at different locations can affect PV panels performances on the one hand and on the other hand, PV panels utilization is cost-effective socially and economically under certain conditions. This chapter presents firstly, the characteristics of the locations where the studies have been conducted, then the materials and methods that have been employed to achieve and set-up the studies, and finally, the data processed.

Thereby, the study areas for technical performances and for the inquiry are in the region of Tillabéry but into two (2) different communes.

### 3.1 Study Areas Presentation

The sites are located in the western part of Niger, in Tillabéri region but are in two (2) different department and commune of the region (See **figures 3-1** and **3-2**).

#### 3.1.1 Technical Performances Study Area

- Sarando Bené is located on the right bank of Niger River, on the road to Namaro (RN6) at 22 km from Niamey and at 17 km from the end township of Niamey, (**Figure 3-1**).
- Geographic Coordinates: Longitude 1° 55' 49.5942" East. and Latitude 13° 35' 9.1788" North.
- The area is located in Bitinkodji (Saga Fonda) commune, Department of Kollo.
- The overall installation (generator and pump) dated from May 2016. The installation is in an area composed of orchard and vegetable garden very close to Niger River. On the River, wet rice is farmed and rain-fed agriculture is the predominant form of acquisition.



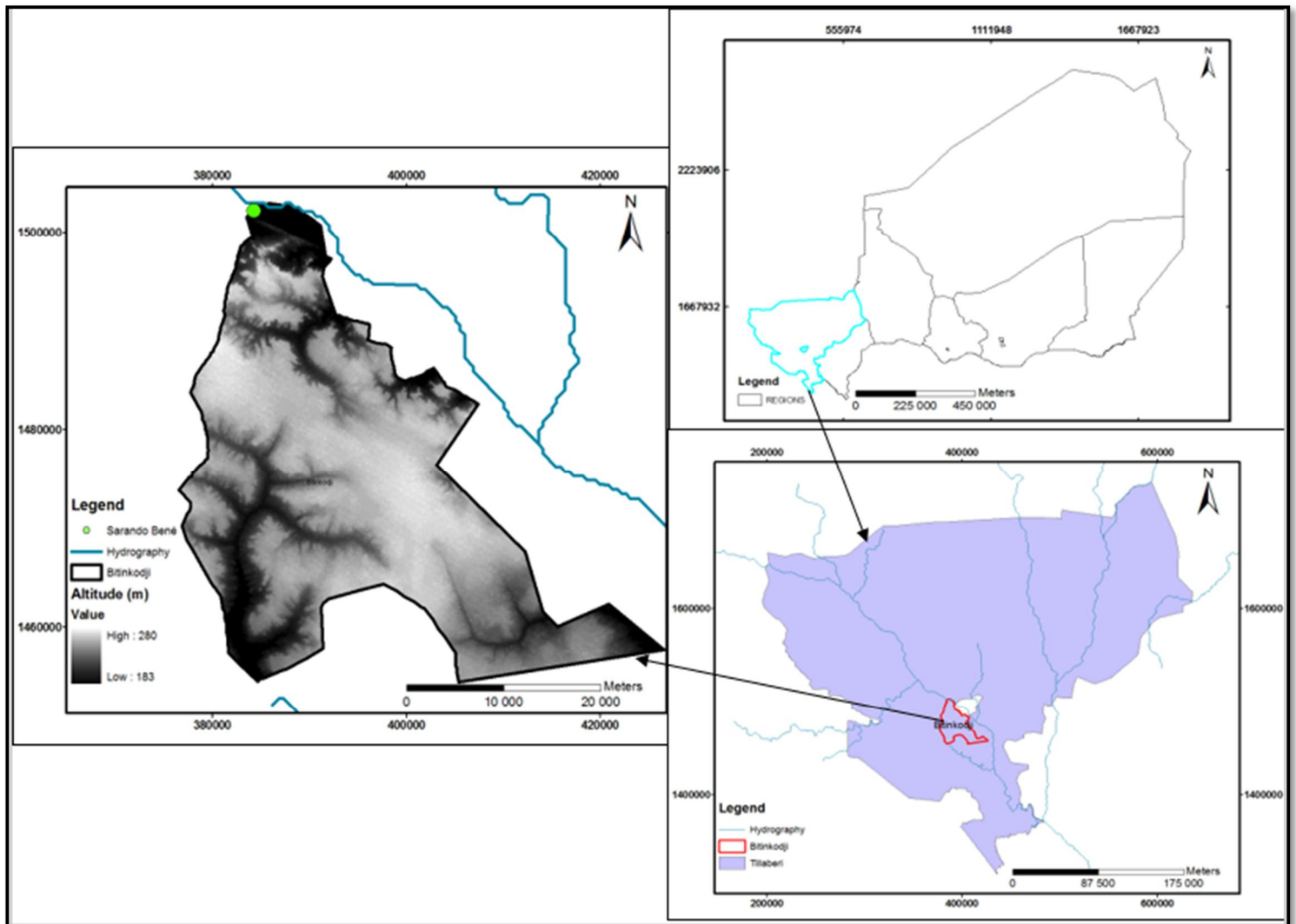

Figure 3-1: Study area of PV installed

### 3.1.2 Socio-Economic Study Area

The geographic coordinates of Kobadjé where the household inquiry has been led, are longitude  $001^{\circ}51'.835$  East and latitude  $13^{\circ}12'.958$  North (**Figure 3-2**). Kobadjé is an administrative village located in the commune of Torodi. This locality is on the road of Torodi at 45–50 km from Niamey the capital city. Kobadjé is a none electrified village but there are many self-installations either for commercial or domestic usage. According to the last 4<sup>th</sup> population census in 2011, the population is about 1 549 inhabitants with 184 households (**INS, 2014**). But with a growth rate estimated at 3.2% for Tillabéri region (**INS, 2013**), the population can be estimated around 1 813 inhabitants in 2017. The major activities of Kobadjé's inhabitants are breeding, farming, gardening, and butchery. The village is an agro-pastoral area. People especially from Niamey, provide themselves with meat and vegetables because of its cheapness compared to urban markets. There are more people and commercial activities during the market day (Monday) which is current in Niger's villages. The village owns two (2) primary schools, one (1) French and Arabic languages primary school, two (2)

Koranic schools, one (1) secondary school, one (1) health center and one (1) borehole functioning with a diesel generator.

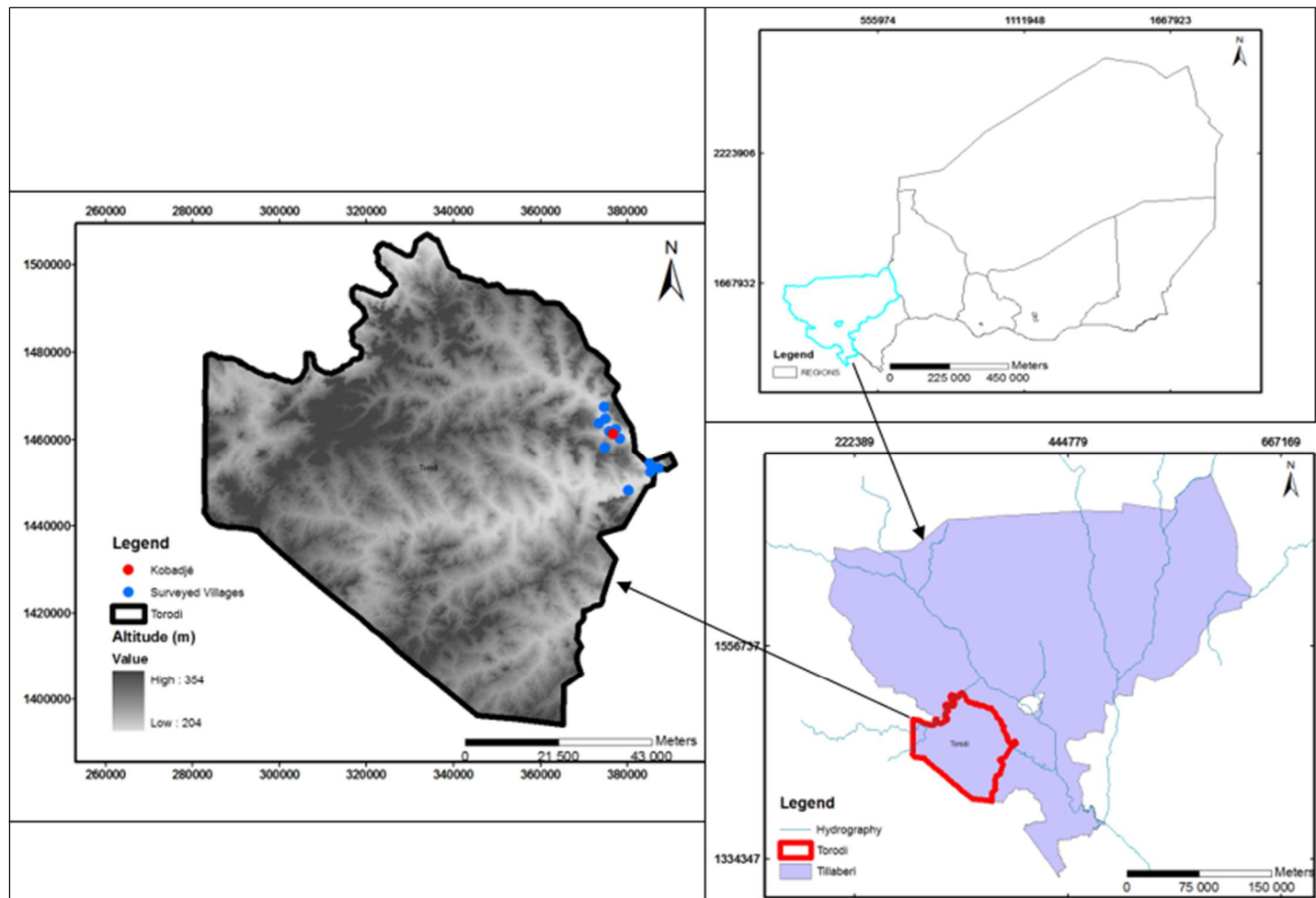

Figure 3-2: Study area with surveyed villages

### 3.1.3 Meteorological Features of the Sites

The two (2) sites are experiencing semi-arid tropical climate and so, located in a *Sahelian* zone with annual precipitations between 300–600 mm, classified as an agro-pastoral zone. Tillabéri is characterized by four (4) well marked seasons: a *dry and cold season* from mid-December to mid-February (temperature 19°C and 27°C); a *dry and hot season* from March to May (temperature 24°C and 35°C); a *rainy season* from June to September (temperature 28°C and 31°C) and a *transitional hot season* without rain from October to mid-December (temperature 16°C and 29°C). Temperatures range from a high of 42°C to a low of 17°C (INS, 2015). The region is dusty especially during the Harmattan which is dry and cold and usually commences in November and ends in February with a strong dusty wind.

## 3.2 Technical Characteristics of Study Installations

The study relates to two (2) solar systems: a solar pump of 1.35 kWp dedicated to the watering of the above-mentioned garden and a solar electricity generation system for the domestic usage of two houses

### 3.2.1 Solar Pump

#### a) Scheme of the Installation

**Figure 3-3** present the general scheme of the solar pump system composed with: a solar panel made up with 13 modules; an Electric pump placed in a borehole water; a borehole of 58 m depth; and, two (2) water backup tanks.

Solar panel of 13 modules in series, as:

- 10 modules 12V/ 75 Wp
- 3 modules 12V/200 Wp

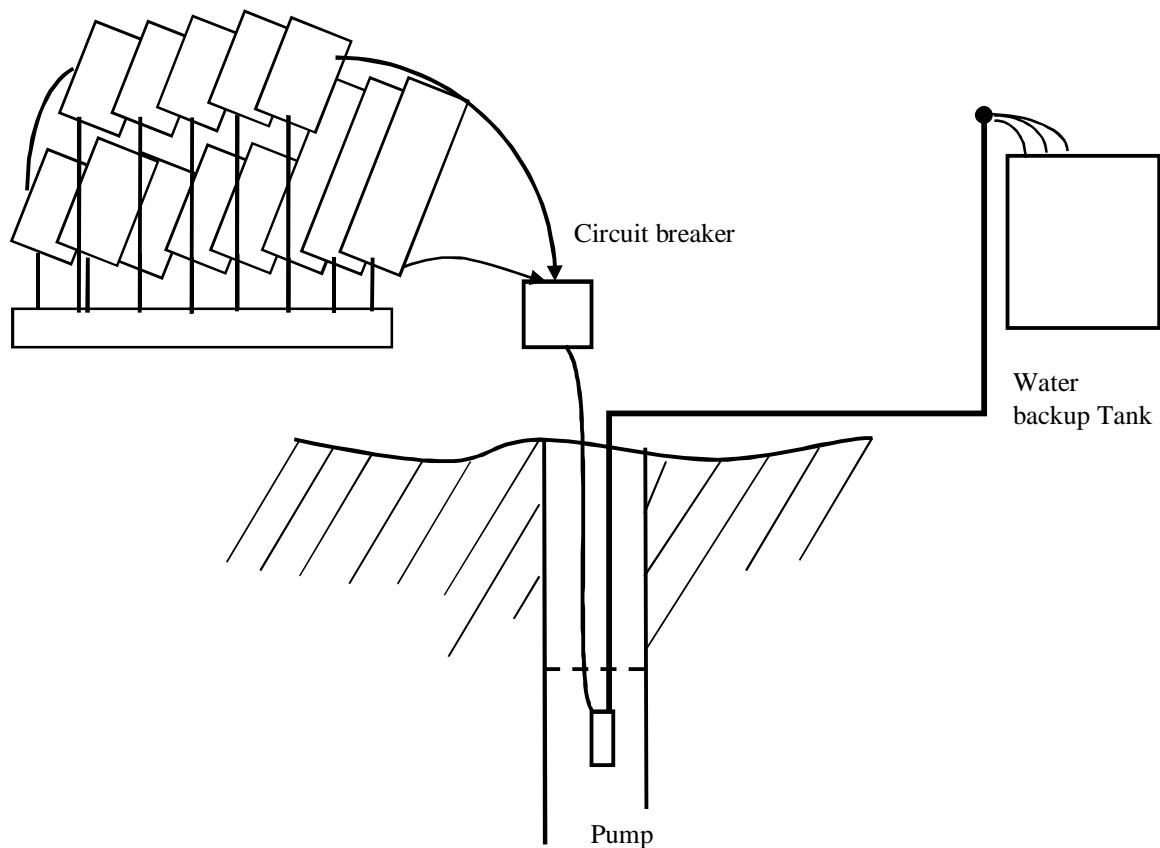

Figure 3-3: Scheme of the solar pump installation

#### b) Characteristics of the Borehole – Water Need and Supply

The borehole, as well as the whole solar pump system, is dedicated to the watering of an orchard and kitchen garden of approximatively one (1) hectare. Before the installation of the solar pump

system, the garden is watered from the Niger river located at about 500 m from the garden, by using a gas motor pump system. In the old time, people used to pump water from two wells currently visible in the garden space. **Table 3-1** reports the main characteristics of the borehole.

Table 3-1: Technical characteristics of the borehole

Characteristics	Flow	Depth	Pump Level	Static Water Level	Dynamic Water Level
Value	6 to 7 m <sup>3</sup> /h	58 m	40 m	4.7 m	16.7 m for pumping flow of 3 m <sup>3</sup> /h

### c) Characteristics of the Panels

Two types of the module have been used, with the respective power of 75 and 200 Wp (See **Figure 3-4**). Each of them has top glass coverage while the bottom is opaque. Their technical characteristics as provided by the manufacturers are reported in **Table 3-2**.

Table 3-2: Technical characteristics of the two PV Module types

N°	Characteristics Parameter	Module of 75 Wp	Module of 200 Wp
1	Technology	Monocrystalline	Polycrystalline
2	Manufacturer	Isòfoton	Sunshine Solar
3	Type	IS – 75 / 12	AP – PM - 200
4	Rating Atmospheric Mass (AM)	1.5	1.5
5	Rating Solar radiation	1000 W/m <sup>2</sup>	1000 W/m <sup>2</sup>
6	Rating temperature	25 °C	25 °C
7	Number of modules	10	3
8	Maximum output voltage (V <sub>max</sub> )	17.3 V	17.5 V
9	Maximum output current (I <sub>max</sub> )	4.34 A	11.42 A
10	Open circuit voltage (V <sub>oc</sub> )	21.6 V	22.05 V
11	Short circuit current (I <sub>sc</sub> )	4.67 A	12.79 A
12	Output Tolerance	± 10%	± 5 %
13	Maximum system voltage DC	760 V	1000 V
14	Maximum series fuse rating		10 A
15	Weight	kg	10.5 kg
16	Panel Dimension		1390 x 986 x 35 mm <sup>3</sup>



Figure 3-4: Photography of the pump and DMG panels, pyranometer, and ambient temperature shelter.

#### d) Technical Characteristics of the Pump

The pump is manufactured by Grundfos and the type is SQ Flex 3A-10. Its nominal crest power is 1.4 kWp and can work in a voltage range of 30 to 300 Vdc. Further technical characteristics are reported in **Figures 3-5** and **3-6**, and in **Table 3-3**.



Table 3-3: Technical specification of the pump

Specifications		Liquid	
Product name	SQF 3A-10	Pumped liquid	Water
Product No	95027336	Maximum liquid temperature	40 °C
EAN number	5700834760099	Liquid temperature during operation	20 °C
		Density	998.2 kg/m³
Technical		Electrical data	
Stages	10	Motor type	MSF3
Approvals on motor nameplate	CE,RCM,EAC	Power input - P1	1.4 kW
Pump No	95027384	Rated voltage ac	1 x 90-240 V
Valve	pump with built-in non-return valve	Rated voltage dc	30-300 V
		Rated current	8.4 A
Materials		Power factor	1,0
Pump	Stainless steel	Rated speed	500-3600 rpm
Pump	DIN W.-Nr. 1.4301	Start. method	direct-on-line
Pump	AISI 304	Enclosure class (IEC 34-5)	IP68
Impeller	Stainless steel	Insulation class (IEC 85)	F
Impeller	DIN W.-Nr. 1.4301	Motor protec	Y
Impeller	AISI 304	Thermal protec	internal
Rotor	DIN W.-Nr. 1.4301	Length of cable	2 m
Rotor	AISI 304	Motor No	96275336
Stator	DIN W.-Nr. 1.4301	Udc	300 V
Stator	AISI 304	Udc	30 V
Installation		Others	
Maximum ambient pressure	15 bar	Minimum efficiency index, MEI ≥	0.70
Pump outlet	Rp 1,25	Net weight	9.5 kg
Minimum borehole diameter	102 mm	Gross weight	11 kg

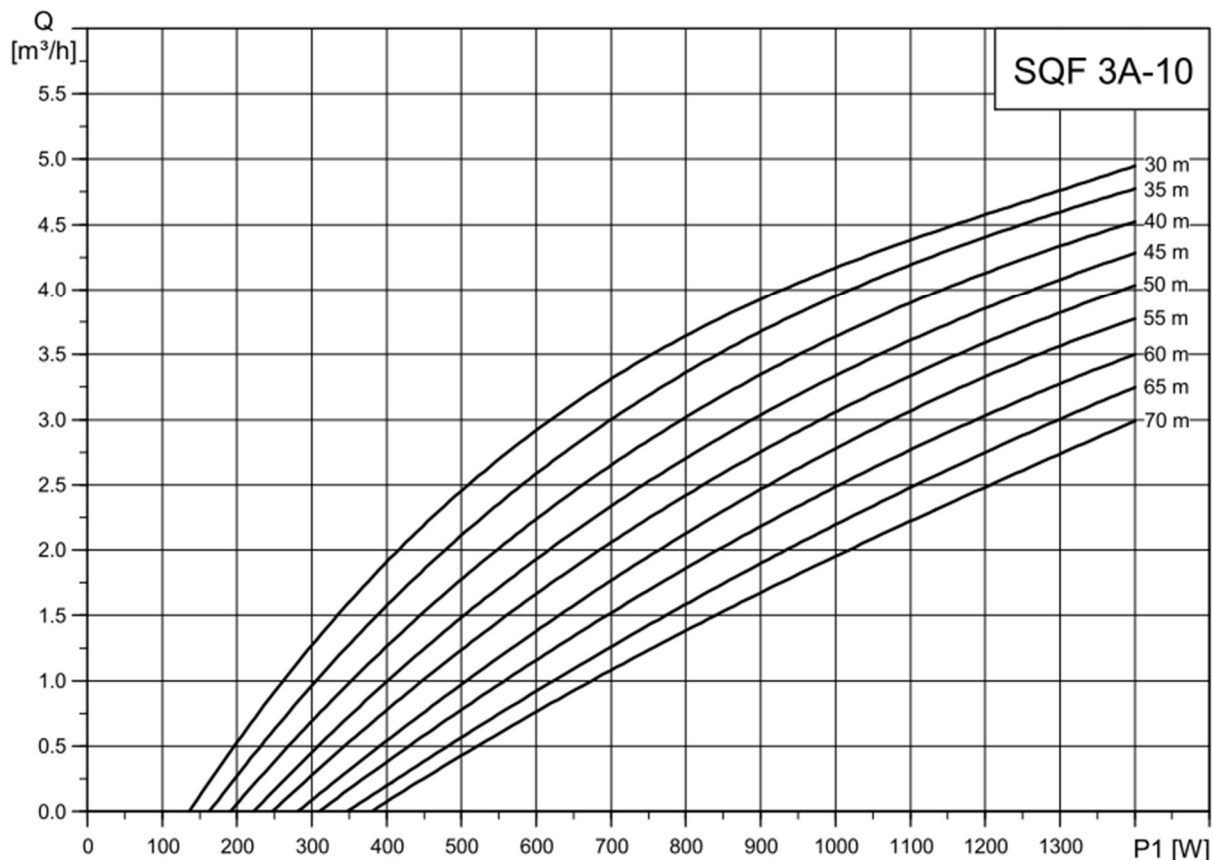

Figure 3-5: Abacus of the pump (power versus height and flow)

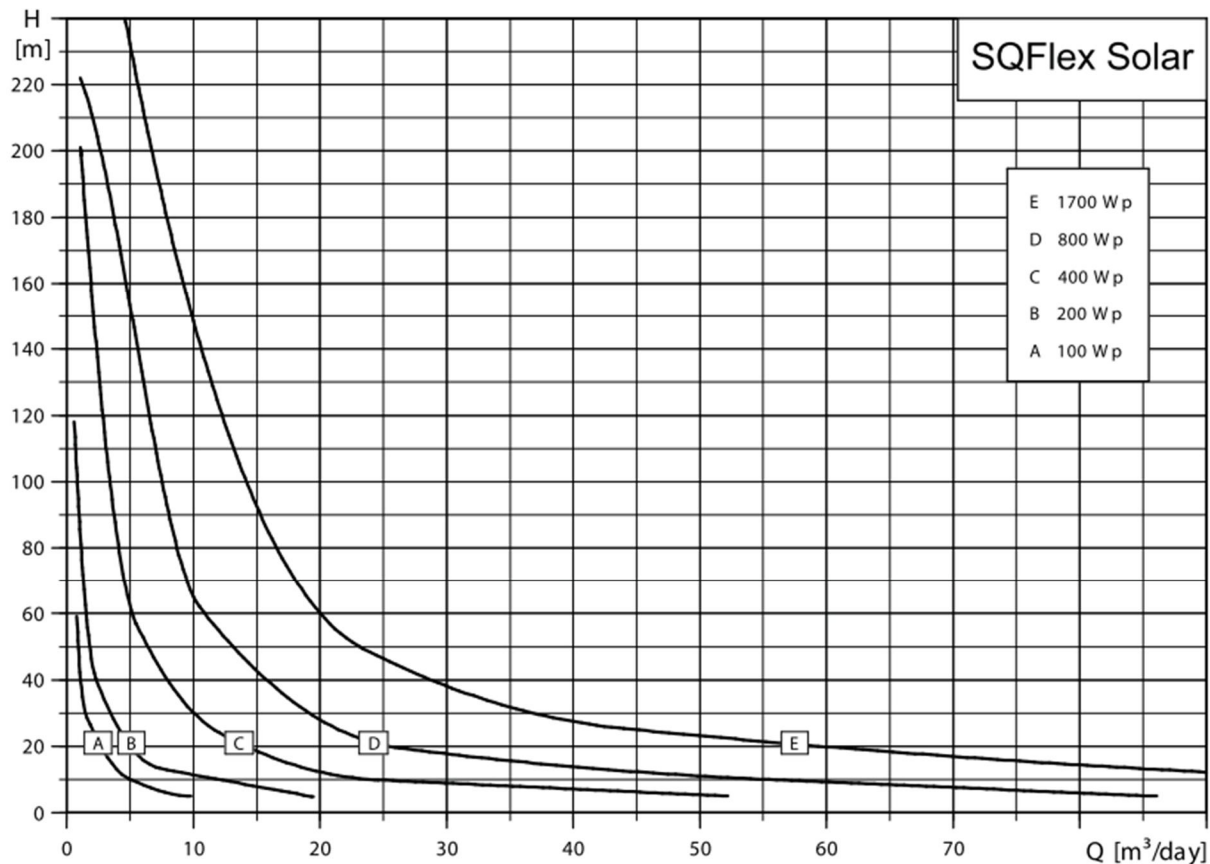

Figure 3-6: Abacus of the pump (flow versus height and power)

### e) Accessories: Backup Tank, Flowmeter, Pipelines

There are two (2) water backup tanks. The little one is of cylindrical form with a content of 3.96 m<sup>3</sup> and placed as high as 6.12 m from the surface and at 10.15 m from the borehole. The small one is of a parallelepiped shape with a content of 3.86 m<sup>3</sup> is located at a height of 0.5 m from the surface and at 100.05 m from the borehole.

To hydraulically link all the system components, pipes of 1 ¼ " diameter have been used.

### f) Specifications of the Installation

All the four arrays of the panels (three for the pump and one for the generator) spouse the north-south position of the building, i.e., 35° East (referred to the magnetic north). The right orientation of the panels should be 0°. The arrays of the panels also spouse the horizontal slope of the roof (east-west, toward the west), which is 3°. All these parameters favor the afternoon period versus the morning period.

**Table 3-4** provides the specification of the horizontal slopes (north-south, toward the south), 6 to 9°, of the arrays compared to the almost plate roof of the building. Thus, the panel position favors summer versus winter.



Table 3-4: Technical characteristics of the panel position

Type of Module	Horizontal slope, North-South
Isòfoton Modules (75 Wp) – North Array	9° (Instead of 15°)
Isòfoton Modules (75 Wp) – South Array	8° (Instead of 15°)
Sunshine Solar Modules (200 Wp)	6° (Instead of 15°)

### 3.2.2 Micro Domestic Generator (MDG)

#### a) Scheme of the Installation

**Figure 3.7** presents the general scheme of the micro domestic generator, which is made up with: a panel of four modules of 150 Wp each, thus totaling 600 Wp; a set of six batteries, each of 200 Ah; an inverter; a charge controller.

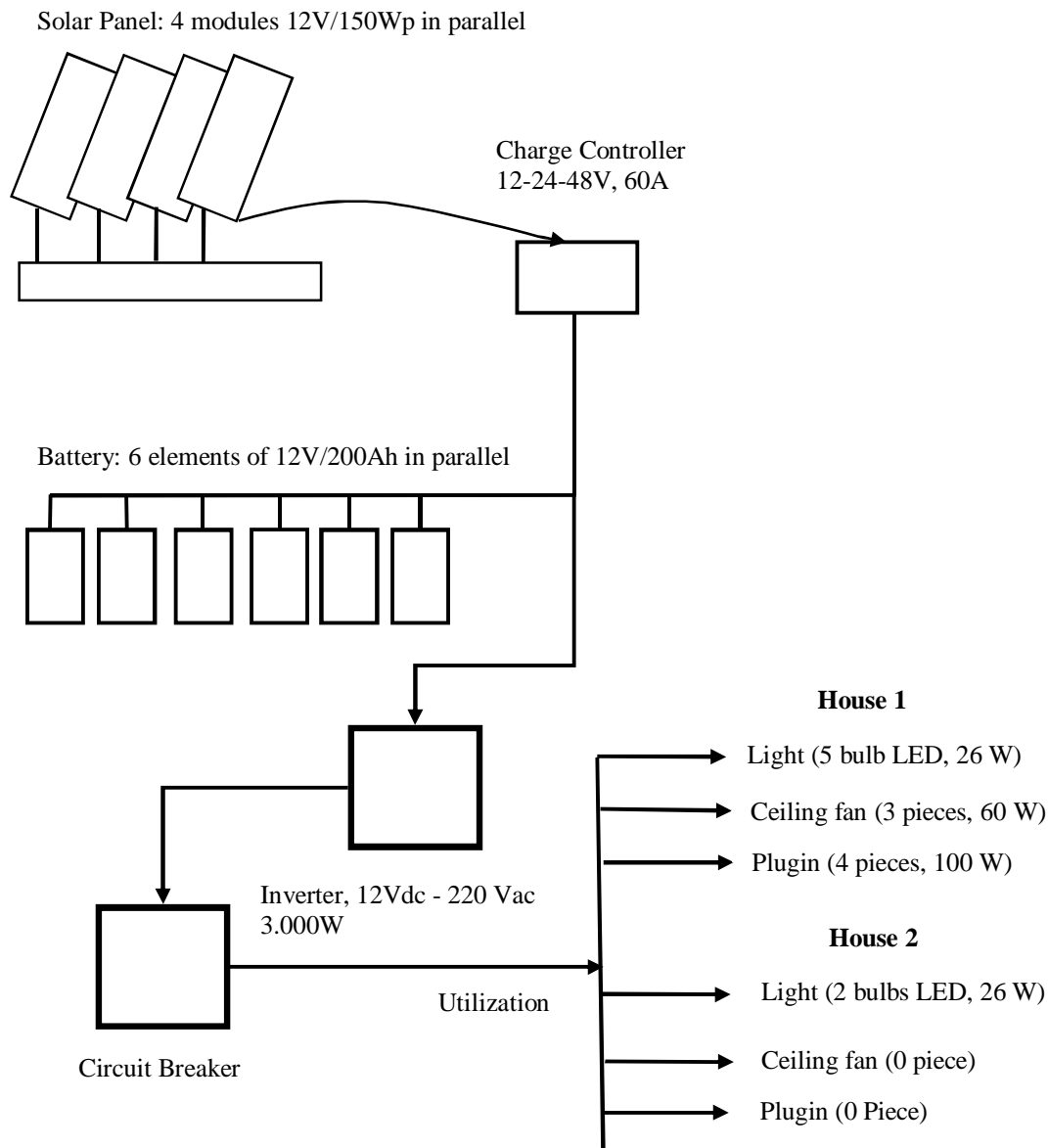

Figure 3-7: Scheme of the Micro Domestic Generator (MDG)

### b) Energy Need

The electric receivers of the MDG installation are reported in **table 3-5**, with their electrical power and the estimated time of utilization. Thus, they include seven (7) lights, three (3) fans, and four (4) plugs. Plugs' power is estimated according to domestic equipment in use locally (TV, computer, fridge, portative water-heater, iron, etc.). It is similar for the time of installation. Usually, their consumption represents one-third of the total consumption.

Table 3-5: Estimation of the daily energy demand

Receivers	Quantity	Power (W)	Use Duration (Hours)	Total Power (W)	Total Energy Demand (Wh/day)
Light	7	26	5	130	910
Ceiling Fan	3	60	16	960	2 880
Plugin	4	100	5	500	2 000
<b>Total</b>				<b>1 590</b>	<b>5 790</b>

Thus, the estimated daily energy demand is 5.79 kWh per day.

### c) Solar Panel Specifications

**Table 3-6** provides the technical characteristics of the MDG modules. The panel is made up of 4 modules of 150 Wp each.

Table 3-6: Technical characteristics of the PV panel

N°	Characteristics Parameters	Module of 150 Wp
1	Technology	Polycrystalline
2	Manufacturer	Sunshine Solar
3	Type	AP-PM-150
4	Rating Atmospheric Mass (AM)	1.5
5	Rating Solar radiation	1000 W/m <sup>2</sup>
6	Rating temperature	25 °C
7	Number of modules	4
8	Maximum output voltage ( $V_{max}$ )	17.5 V
9	Maximum output current ( $I_{max}$ )	8.57 A
10	Open circuit voltage ( $V_{oc}$ )	22.05 V
11	Short circuit current ( $I_{sc}$ )	9.6 A
12	Output Tolerance	± 5 %
13	Maximum system voltage DC	1000 V
14	Maximum series fuse rating	10 A
15	Weight	Kg
16	Panel Dimension	mm <sup>3</sup>

#### d) Batteries

**Table 3-7** reports the technical characteristics of the batteries. The system is made up of 4 batteries set together in parallel.

*Table 3-7: Technical characteristics of the batteries*

N°	Characteristic Parameters	Value
1	Manufacturer	Isòfoton
2	Type	Sealed Lead BT200 – 12 HC
3	Number	4
4	Nominal Voltage	12 V
5	Capacity	200 Ah
6	Cyclic use	14.4 – 15.0 V
7	Standby use	13.5 – 13.8 V
8	Initial current	Less than 50 A

#### e) Charge Controller

**Figure 3-8** presents the scheme of the charge controller connection. Only two cables have been connected instead of three. One is the cable of solar panel and the other is for batteries. The cable of the inverter is absent although it is specified in **Table 3-8**, that the inverter has not any built-in solar controller and nor auto switch over.

*Table 3-8: Technical characteristics of the charge controller*

N°	Characteristic Parameters	Value
1	Manufacturer	Tristar
2	Type	TS-60
3	Maximum current ratings (solar and load current)	60 A
4	Range of operating temperature TC	40-45°C
5	Nominal Voltage	12 – 24 - 48 Vdc
6	Range of operating voltage	10 – 68 Vdc
7	Minimum interrupting current rating	75 A
8	Maximum solar input (open-circuit) Voltage Voc (Vdc)	125 Vdc



Figure 3-8: Photography of the charge controller connected

#### f) Inverter

**Table 3-9** reports about the specifications of the inverter. Any information about the efficiency of the device has been provided.

Table 3-9: Technical characteristics of the inverter

N°	Characteristic Parameters	Value
1	Manufacturer	EMC
2	Type	
3	Input voltage DC	12 Vdc
4	Output voltage AC	220 Vac
5	Output power	Unspecified
6	Frequency	50 Hz
7	Wave form	Modified sine wave
8	Auto switchover	No
9	Build-in charger	No
10	Build-in solar controller	No
11	Regulation compliance	ROHS

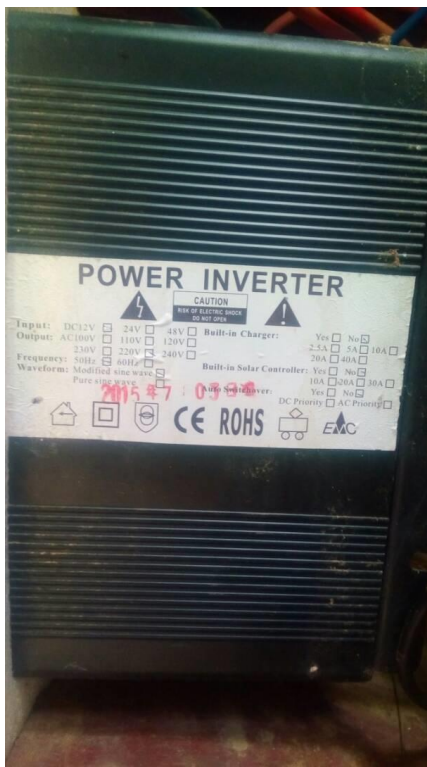

Figure 3-9: Photography of the inverter connected

### g) Specification of the Installation

As stated in **Section 3.2.1 f)**, the array of the panel spouses the north-south position of the building, i.e., 35° East (referred to the magnetic north), and the horizontal slope of the roof (east-west), which is 3°.

The horizontal slope, north-south, of the panel, is 7°, instead of 13.5° which is the latitude of the location.

### 3.2.3 Measurement Sensors and Datalogger

**Table 3-10** reports on the utilization plan of the sensors, while **Appendix A** specifies the connection plan of the sensors to the datalogger as well as the running program of the latter.

Table 3-10: Framework of the utilization of measurement sensors

N°	Measured Parameter	Sensor	Observations
1	Solar radiation	Pyranometer	See Table 3-11
2	Temperature, ambient	Thermocouple E	
3	Temperature, Isòfoton module	Thermocouple E	
4	Temperature, Sunshine module	Thermocouple E	
5	Voltage Isòfoton module	1MΩ and 10kΩ resistances	
6	Voltage Sunshine module pump	1MΩ and 10kΩ resistances	
7	Voltage Sunshine module generator	1MΩ and 10kΩ resistances	
8	Voltage Battery	1MΩ and 10kΩ resistances	
9	Current Panel Pump	Shunt of 20 A	
10	Current Panel Generator	Shunt of 100 A	
11	Current Battery – Inverter	Shunt of 100 A	
12	Current Output Inverter	Shunt of 5 A	
13	Level of water	Water-level sensor	Manual measure
14	Water flow	Flow meter	Manual measure

#### a) Pyranometer

The pyranometer is placed on the roof of the house, nearby the solar panels, as showed in **Figure 3-4**. The support of the pyranometer has a variable slope from 15 to 20°. The characteristics of the pyranometer are reported in **Table 3-11**.

Table 3-11: Technical characteristics of the pyranometer

N°	Parameter	Value
1	Manufacturer	Kipp & Zonen
2	Model and serial number	CMP 3 and 114792
3	Reference	CMP 3 sn060193
4	Sensitivity	12.40 μV/W/m <sup>2</sup> at normal incidence

#### b) Thermocouple

- Thermocouple type E<sup>1</sup>
- One for the measurement of ambient temperature (see **figure 3-4**) and

<sup>1</sup> Thermocouple type E, Chromel (alloy nickel+chrome (10%) / Constantan (Alliage nickel+cuivre (45%))

- Two for the measurement of panels' temperature (one for Isòfoton panel and the other for Sunshine Solar panel)

#### c) Other Minor Measurement Equipment

Other minor measurement equipment includes:

- (1) Voltmeter PeakTech 3335 DMM.
- (2) Resistances for voltage measurement:
  - 1 M $\Omega$  (4 pieces, panel 3, battery 1);
  - 10 k $\Omega$  (4 pieces, panel 3, Battery-Inverter 1).
- (3) Shunts for current measurement:
  - 5A (1 piece, for output inverter);
  - 20A (1 pièce for pump panel);
  - 100A (2 pieces for generator panel and battery - inverter).
- (4) Water-level sensor.
- (5) Water flow meter.

#### d) Datalogger

The data logger used is CR1000 of Campbell Scientific Company, which is made up of 8 double connections (See **Figure 3.10** and **figure 3-11**). The scheme of connection adopted is reported in **Appendix A**. The Datalogger has been programmed as it is reported in **Appendix B**.



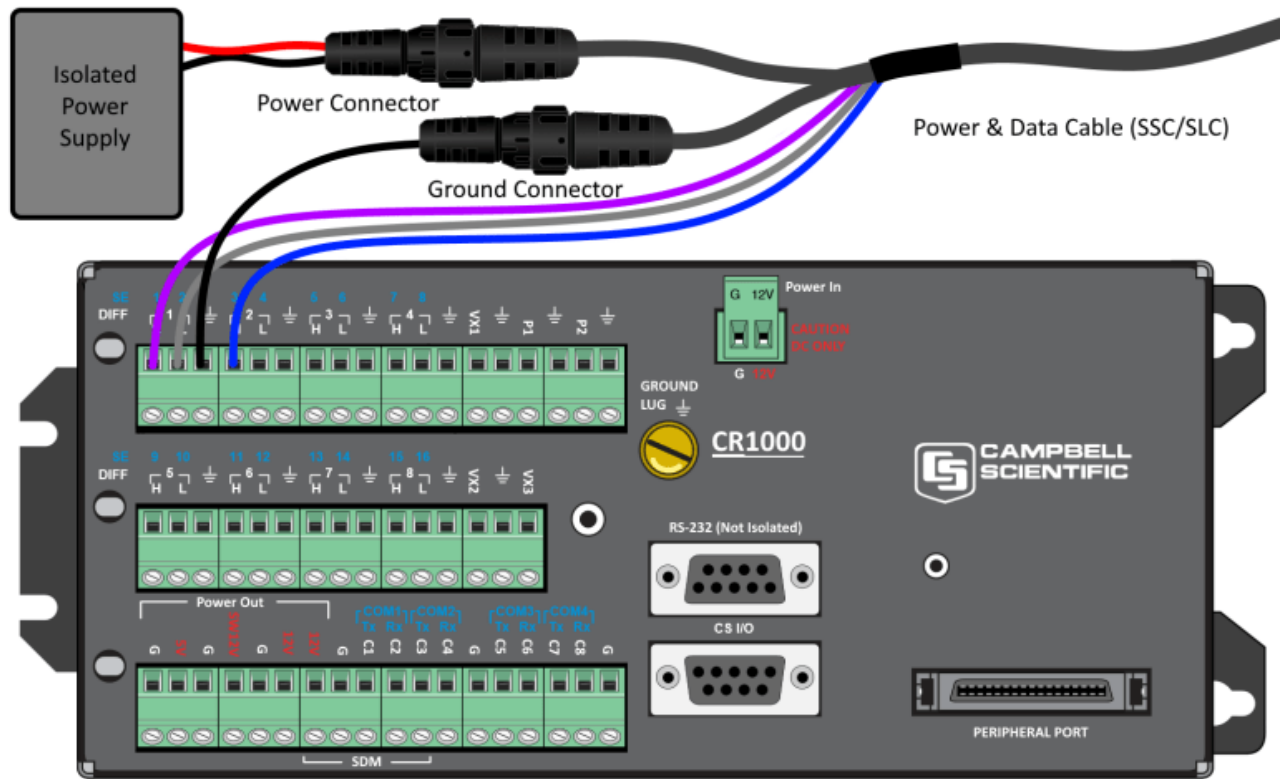

Figure 3-10: CR1000 Datalogger, Campbell Scientific

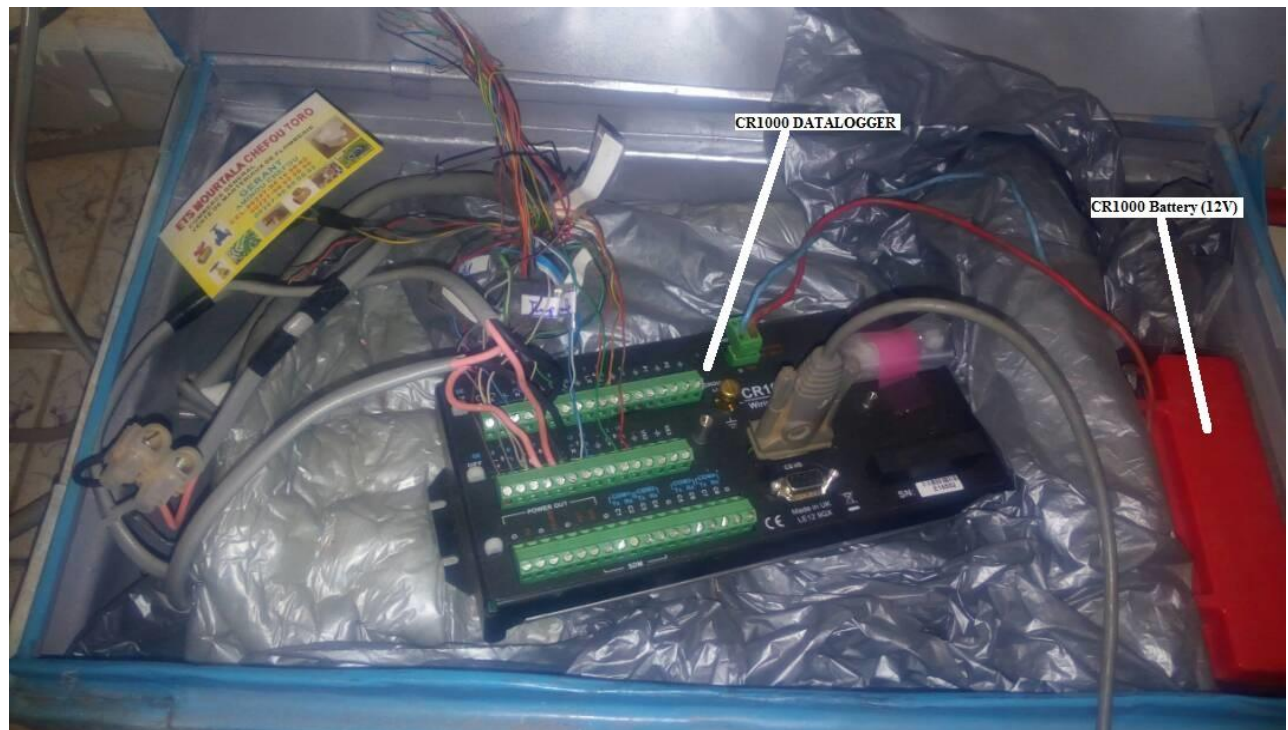

Figure 3-11: Photography of CR1000 Datalogger

### 3.2.4 Experiment Running

Two set of experiments have been carried out: the free-running experiment and the monitored experiment.

#### a) Free Running experiment

- Panels never cleaned.
- Data are recorded during the utilization of the devices.
- From 03 to 22 November 2017.
- Pumping and non-pumping data.

Table 3-12: Specifications of the free pumping period

N°	Date	Beginning	End	Duration (hours)
1	03/11/2017	10 : 25 AM	12 : 25 PM	2.00
		2 : 00 PM	3 : 00 PM	1.00
		3 : 25 PM	3 : 35 PM	0.17
2	04/11/2017	10 : 25 AM	11 : 20 AM	0.92
		1 : 55 PM	3 : 20 PM	1.42
3	05/11/2017	10 : 45 AM	10 : 50 AM	0.08
		12 : 45 PM	2 : 35 PM	1.83
4	06/11/2017	12 : 10 PM	1 : 50 PM	1.67
5	07/11/2017	1 : 25 PM	2 : 40 PM	1.25
6	08/11/2017	9 : 55 AM	11 : 35 AM	1.67
7	09/11/2017	9 : 30 AM	10 : 10 AM	0.67
		12 : 05 PM	1 : 05 PM	1.00
8	10/11/2017	9 :50 AM	10 : 30 AM	0.67
9	11/11/2017	9 : 45 AM	12 : 30 PM	2.75
10	12/11/2017	9 : 45 AM	11 : 05 AM	1.33
		2 : 05 PM	3 : 15 PM	1.17
11	13/11/2017	2 : 15 PM	3 : 10 PM	0.92
12	14/11/2017	9 : 45 AM	10 : 55 AM	1.17
13	15/11/2017	9 : 45 AM	12 : 00 PM	2.25

14	16/11/2017	1 : 25 PM	2 : 15 PM	0.83
15	17/11/2017	8 : 30 AM	11 : 05 AM	2.58
		12 : 15 PM	12 : 45 PM	0.5
16	18/11/2017	9 : 35 AM	10 : 25 AM	0.83
		14 : 15 PM	3 : 25 PM	1.17
17	19/11/2017	10 : 20 AM	2 : 35 PM	4.25

### b) Monitored experiment

Specific experiments intended to evaluate some parameters with more precision have been carried out. During these sessions, panels are systematically cleaned at every session. **Table 3-13** reports the main dates of these experiments.

*Table 3-13: Specifications of the controlled pumping period*

N°	Date	Beginning	End	Duration (hours)
1	29/11/2017	10 : 05 AM	1 : 25 PM	3.5
2	02/12/2017	9 : 30 AM	1 : 00 PM	3.5
3	16/12/2017	10 : 10 AM	1 : 30 PM	3.33
4	18/12/2017	10 : 35 AM	1 : 35 PM	3.00
5	19/12/2017	10 : 15 AM	12 : 45 PM	2.50

## 3.3 Socio-Economic Study Material and Method

### 3.3.1 Local Inquiry in a small size village Kobadjé

To identify the impacts of PV systems utilization in a rural area, a socio-economic survey has been conducted in Kobadjé only for the household survey, but for commercial purpose, the inquiry concerned mostly Kobadjé and some villages around Kobadjé such as Bololadié, Laoudou, Dianhoé, Finfetou, Piliki. The socio-economic survey focused on the motivation, challenges, and benefits perceived by people that decided to install PV systems for commercial or domestic activities.

For this, a sample of about 47% of the total number of randomly selected households in Kobadjé communities was surveyed. Approximately 101 surveys were completed for household (**See Appendix D**) and 90 surveys for investors (**See Appendix E**) in solar PV systems.

To achieve the objectives set, a method of analysis based on the analysis of primary data, namely socio-economic surveys was used.

The material used in this approach is the Sphinx Software for the development of the survey questionnaires, the data acquisition and the processing of survey data.

## Partial Conclusion

This chapter has described the materials used during the experiments whether it is for the PV systems technical parameters under real outdoor conditions with all the climatic conditions or for the socio-economic inquiries in that local village named Kobadjé. At first sight, the experimental designs consisted of data procurement of measured parameters from both datalogger and manually record during pumping and non-pumping period but also for the MDG where the data are recorded from the datalogger only.

Afterwards, based on the surveys of 101 individuals and 90 businesses with solar installed on their properties, the responses processing through the Sphinx software have been completed in order to evaluate the social or economic benefits of solar panels to the local community.

## **CHAPTER IV: RESULTS, ANALYSIS, AND INTERPRETATION**

## Introduction

This chapter presents the results of the experiments under real conditions at a specific location and the socio-economic surveys' responses that have been collected. Thereby, these results will be analyzed and interpreted, leading to a conclusion.

### 4.1. Technical Performances Study

The results are related to the performances of the following apparatus:

- (i) modules from Isòfoton and Sunshine Solar for the solar the pump and from Sunshine Solar for the generator;
- (ii) pump manufactured by Grundfos;
- (iii) battery, manufactured by Isòfoton for the generator;
- (iv) inverter from EMC for the generator;
- (v) charge controller provided by TriStar for the generator.

#### 4.1.1. Solar Panel Performances

##### a) Intrinsic Performances of Solar Pump Panels

In addition to the characteristics provided in **Table 3-1**, each cell can be more described by its current generation constant,  $\alpha$ , and its saturation current,  $I_0$ . The two constants can be obtained first by using the data provided by the manufacturer through **equations (17) and (19)**. The result is reported in **Table 4-1**.

Table 4-1: Characteristic constants of the two PV Module types (See Table 3-1)

Specifications	Characteristic Parameter	Isòfoton	Sunshine Solar
Provided by Manufacturer	Rating Solar radiation	1000 W/m <sup>2</sup>	1000 W/m <sup>2</sup>
	Rating temperature	25°C	25°C
	Open circuit voltage (V <sub>oc</sub> )	21.6 V	22.05 V
	Short circuit current (I <sub>sc</sub> )	4.67 A	12.79 A
Deduced	Energy efficiency	12%	17%
	Fill factor (FF)	0.74	0.71
	Photo generation current constant, $\alpha$	0.27 A/W	0.39 A/W
	Saturation current per cell, I <sub>0</sub>	3.30 10 <sup>-10</sup> A	5.55 10 <sup>-10</sup> A
	Saturation current per unit, J <sub>0</sub>	1.90 10 <sup>-8</sup> A/m <sup>2</sup>	1.71 10 <sup>-8</sup> A/m <sup>2</sup>
	Band gap for idealistic factor equal to 1	0.895 eV	0.898 eV
Evaluated	Technology	Monocrystalline	Polycrystalline
	Number of cells	36	72
	Cell area	173.25 cm <sup>2</sup>	162.75 cm <sup>2</sup>
	Equivalent cell area	Idem	325.50 cm <sup>2</sup>
	Active module area	0.62 m <sup>2</sup>	1.17 m <sup>2</sup>
	Module Power	75 W <sub>p</sub>	200 W <sub>p</sub>
	Number of modules	10	3
	Share of power	56%	44%

According to literature, the photogeneration current constant is usually around 0.35 A/W for silicon mono or polycrystalline cell (**Roger, 1993**). This is in accordance with our data (**Table 4-1**), except that the constant is higher (better) than the one reported for Sunshine Solar cells (0.39) and lower (worse) for Isòfoton cells (0.27).

For good solar cells, saturation current is around  $J_o \approx 10^{-8} \text{ A m}^{-2}$  (**Tiwari, 2002**). This is in accordance with the data of **Table 4-1** for Isòfoton cell ( $1.9 \cdot 10^{-8}$ ) as well as for Sunshine Solar ( $1.71 \cdot 10^{-8}$ ).

**Equation (20)** specifies that the band gap, E<sub>g</sub>, of material is generally taken to 1.11 eV (**Tiwari, 2002**), for the silicon cell (according to some sources 1.7 to 1.8 eV, **Roger, 1993**). For the used

material, the band gap can be estimated to 0.896 eV, which means that the materials are rather more sensitive to temperature increase (See **Equation 20**).

In field efficiency of Isòfoton Panel, roughly 10% (**Figure 4-1**) for solar radiation variation from 500 to 900 W/m<sup>2</sup> in spite of dust (never cleaned) and temperature of 42°C on the back cover of the module. This value is lower than the standard value the efficiency provided by the manufacturer, which is 12 % (See **Table 4-1**). The efficiency loss (-18 %) can be explained by the presence of dust and by the bad orientation of the panels (See **Section 3.2.1 f**).

This result is not accurate and it needs to be more specified, since the coefficients of the photogenerated current,  $\alpha$ , and the fill factor, FF, of **Equation (24)**, have not been experimentally evaluated.

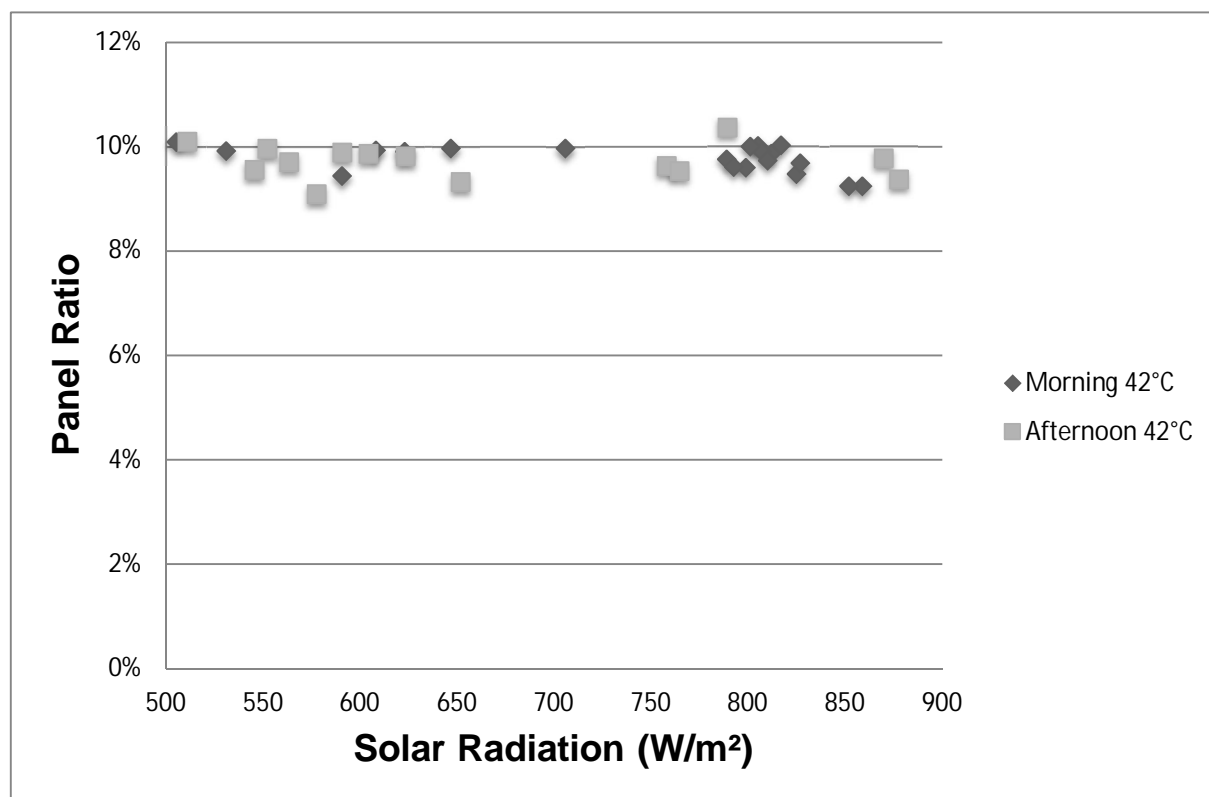

Figure 4-1: In field Isòfoton panel ratio (21/11/2017)

The performance ratio (PR) is the ratio of the actual energy production to the energy production that would be obtained if the PV modules always performed at the nominal efficiency and there were zero losses in the other components of the system (such as inverters). Thus, according to Didier Mayer and Michael Heidenreich in 2003, the higher PR is, the better the system uses its potential. A low PR value means production loss due to technical or design problems.

## b) Working Performances of the Pump Panels



**Figure 4-2** shows Isòfoton and Sunshine Solar panels ratio while the pump is running for solar radiation variation from 700 to 900 W/m<sup>2</sup>. The panels have cleaned and well positioned for this set of experiments. Thus, Isòfoton panel recorded 8% of ratio while the Sunshine one shows a ratio of 5.5%.

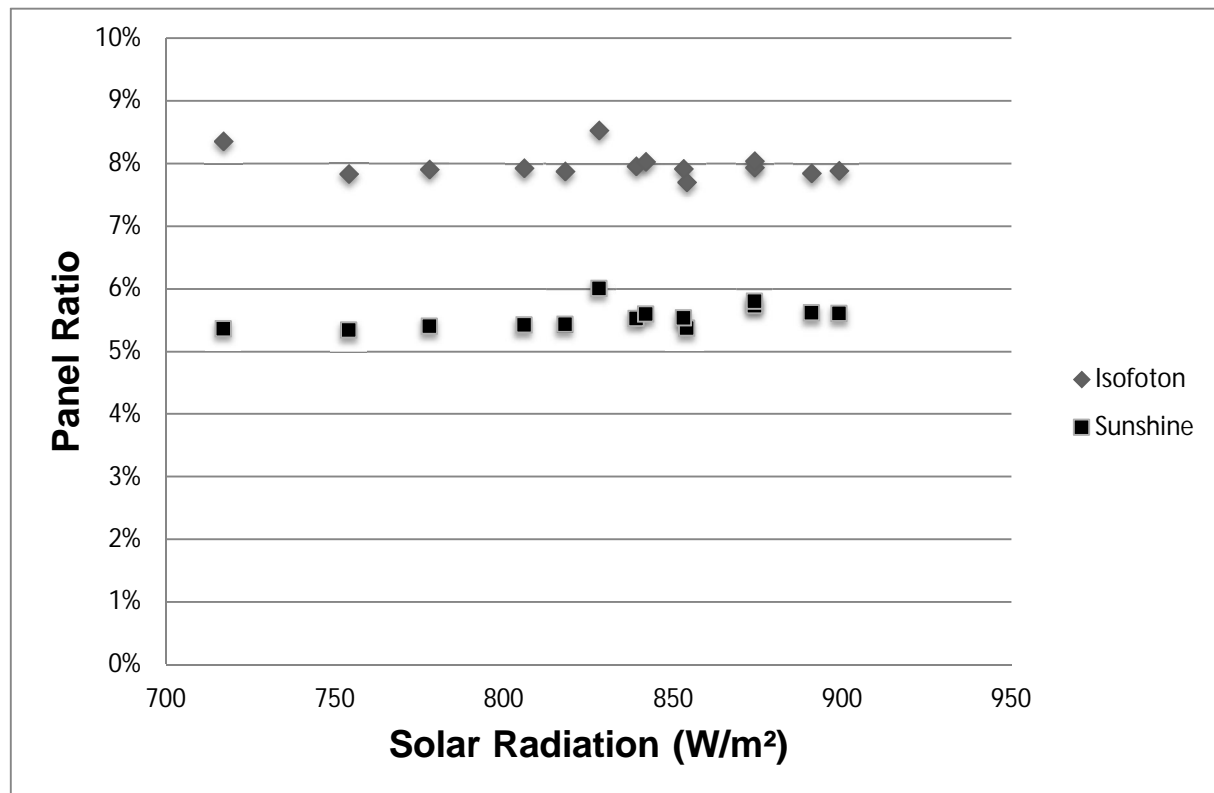

Figure 4-2: Isòfoton and Sunshine Solar panel ratio while the pump running (19/12/2017)

The working performance of panels is a matching exercise between the Isòfoton panels, the sunshine panels and the pump itself. **Figure 4-3** presents the variation of the two types panels voltages with solar radiation while the pump running. When the solar radiation increases, the voltage of the Isòfoton panels moves away from values next to the maximum power output voltage (17.3 V in the standard conditions) to values around 13 V. While the voltage of the Sunshine Solar panels moves toward the maximum power output voltage (17.5 V). In fact, the two voltages are much correlated as it can be noticed in **Table 4-2**. Thus, we can write:

$$V_{Suns} = aV_{Isof} + b \quad (31)$$

Where:

- $V_{isof}$  is the Isòfoton panel voltage;
- $V_{suns}$  is the Sunshine Solar voltage.

Table 4-2: Voltage correlation between Isòfoton and Sunshine panels the pump running

Date	Number of Data	Constant a	Constant b	Correlation R <sup>2</sup>
16/12/2017	19	0.556	10.810	0.944
19/12/2017	14	0.618	9.786	0.876
<b>Average</b>		<b>0.587</b>	<b>10.298</b>	

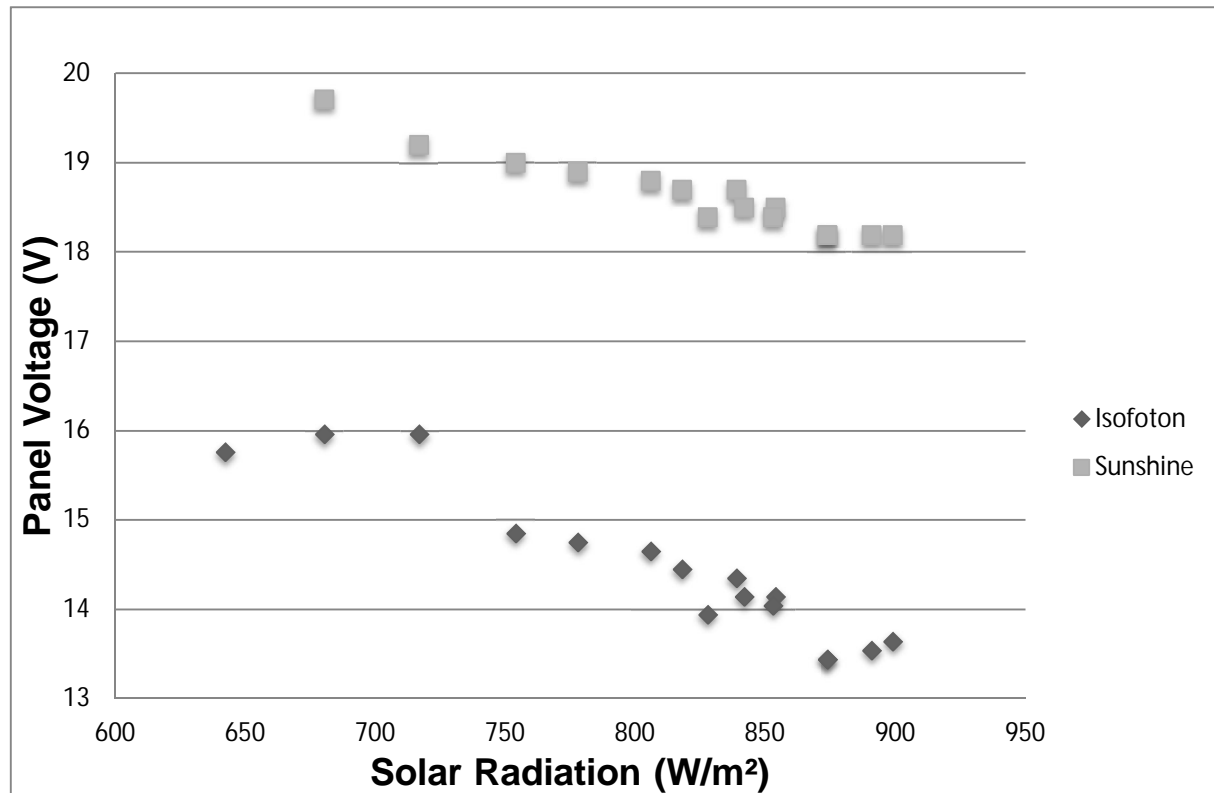

Figure 4-3: Variation of the two types panels voltage with solar radiation (19/12/2017)

When two solar panels are set in series, the working current is the same for all of them. So, the I-V characteristic curve of the equivalent array is found by adding the two voltages for each value of the I-V characteristic curves of the two panels. The working point is found by charting the I-V characteristic of the receiver on the sum I-V characteristic curve of the array.

In the present case of the solar pump, the equivalent I-V characteristic curve is obtained by adding the ten (10) Isofoton panels curve to the one of the three (3) Sunshine Solar panels. Then the impedance of the solar pump is charted. All these are reported in **Figure 4-4**, where one can see the functioning point of the system made up of a mixture of panels and a pump. The parameters leading to the chart of the panels' I-V characteristic curves are reported in **Table 3-2**. Thus, we notice that the functioning point of the system is very close to the parameters of the Isofoton panels. This is in accordance with the measured data (See **Figure 4-5**) where current values lower than 4A have been observed.

The relative power of the panel,  $R_p$ , can be expressed as:

$$R_p = \frac{P_p}{P_c} \tag{32}$$

Where:

- $P_p$  is the panel power;
- $P_c$  is the crest installed power (1,350 Wp).

With this unbalanced system, the pump draws less than 50 % of the crest installed power as illustrated in **Figure 4-6**.

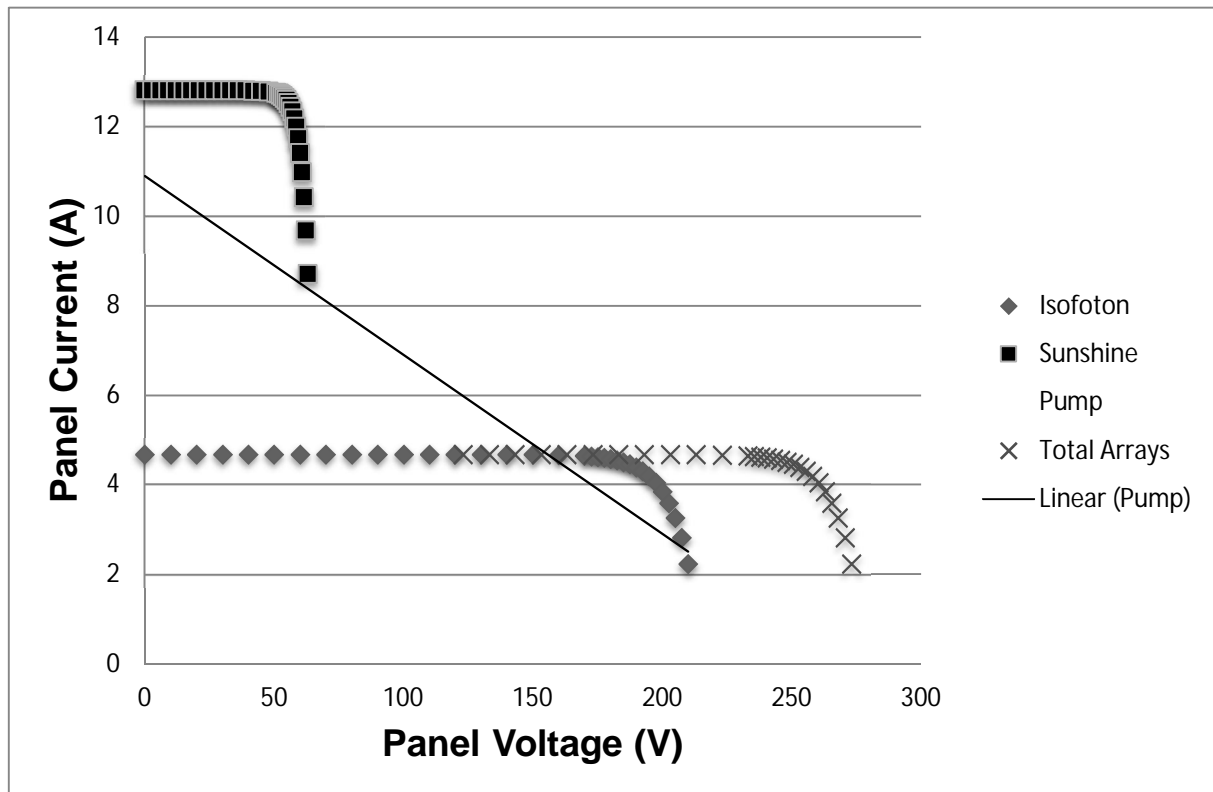

Figure 4-4: I-V characteristic curves of the two sets of panels and their addition

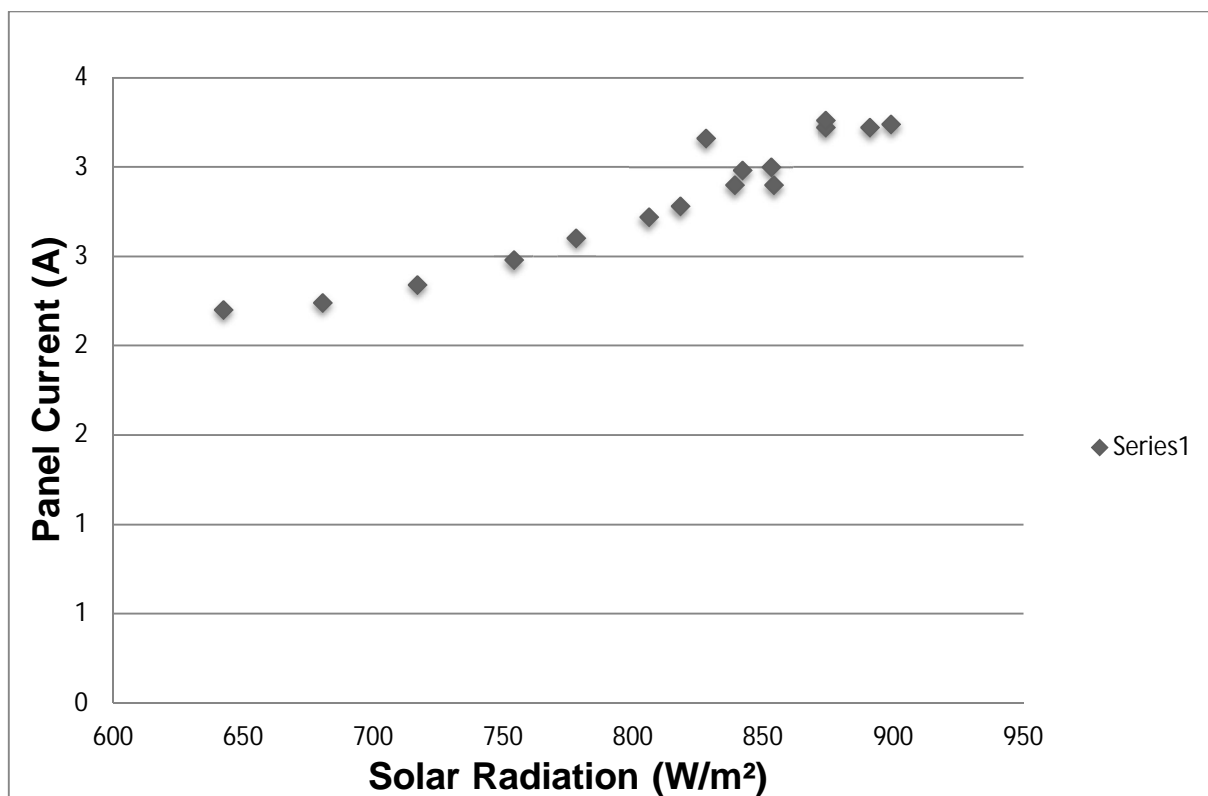

Figure 4-5: Variation of the current with the solar radiation (19/12/2017)

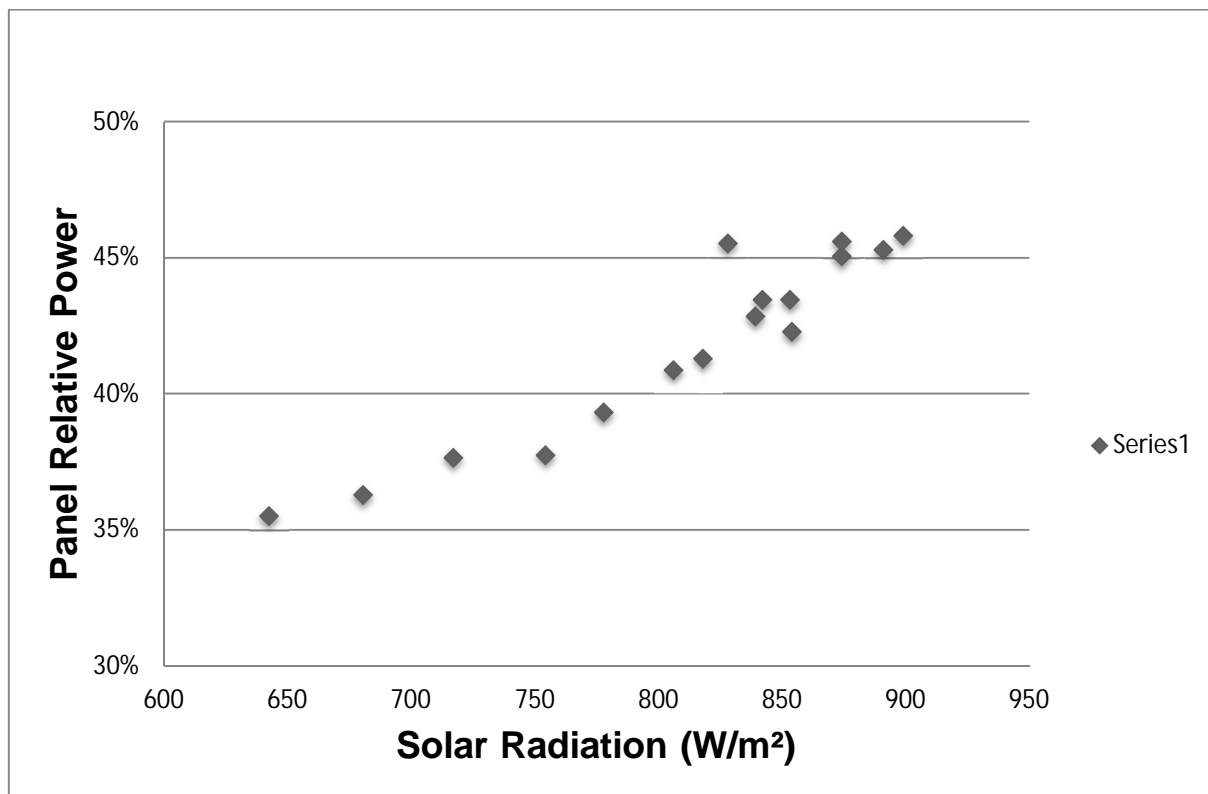

Figure 4-6: Variation of the relative power with the solar radiation (19/12/2017)

### c) Performances of the Generator Panels

As for the pump panel, the parameters of **Table 4-1**, are reported in **Table 4-3** for the generator panels manufactured by Sunshine Solar. The photogeneration current constant is roughly the same for the two Sunshine Solar modules (0.4 for the 150 Wp Sunshine Solar panel versus 0.39 for 200 Wp). The same observation is valid for the saturation current which is around  $1.71 \cdot 10^{-8}$  A/m<sup>2</sup>, as well as for the band gap estimated to 0.896 eV.

Table 4-3: Characteristic constants of the PV Module types (See Table 6)

Specifications	Characteristics Parameters	Sunshine Solar
Provided by Manufacturer	Rating Solar radiation	1000 W/m <sup>2</sup>
	Rating temperature	25°C
	Open circuit voltage ( $V_{oc}$ )	22.05 V
	Short circuit current ( $I_{sc}$ )	9.6 A
Deduced	Energy Efficiency	17 %
	Fill factor (FF)	0.71
	Photo generation current constant, $\alpha$	0.40 A/W
	Saturation current per cell, $I_0$	$4.17 \cdot 10^{-10}$ A
	Saturation current per unit, $J_0$	$1.72 \cdot 10^{-8}$ A
	Band gap for idealistic factor equal to 1	0.898
Evaluated	Technology	Polycrystalline
	Number of cells	72
	Cell area	120.90 cm <sup>2</sup>
	Equivalent cell area	241.80 cm <sup>2</sup>
	Active panel area	0.87 m <sup>2</sup>
	Number of modules	4
	Module Power	150 Wp

The right crest installed power is given by **Equation (28)**. But its application requires the data of **Table 4-3**. Thus, the crest installed power should be 1,340 Wp instead of 600 Wp, which represents 45% of the required crest power.

Table 4-4: Parameters required for the evaluation of crest installed power

N°	Parameter	Value	Reference
1	Daily energy demand	5 790 Wh/day	<b>Table 3-5</b>
2	Number of equivalent hours	4.9 hours	<b>Table 1-5</b>
3	Battery efficiency	higher than 90 %	<b>Table 4-7</b>
4	Inverter efficiency	98 %	<b>Table 4-8</b>

#### d) Influence of Temperatures on panels Performance

**Figure 4-7** shows how different cell materials lose efficiency with increasing temperature (SERI, 1981). Note that at normal terrestrial temperatures, 25°C, silicon's efficiency compares favorably with other materials; but at high temperatures, 200°C for instance, silicon's efficiency has dropped to 5%, whereas the other materials are near 12%. Silicon is a good material for ambient temperature terrestrial uses; it fails in high-temperature applications.

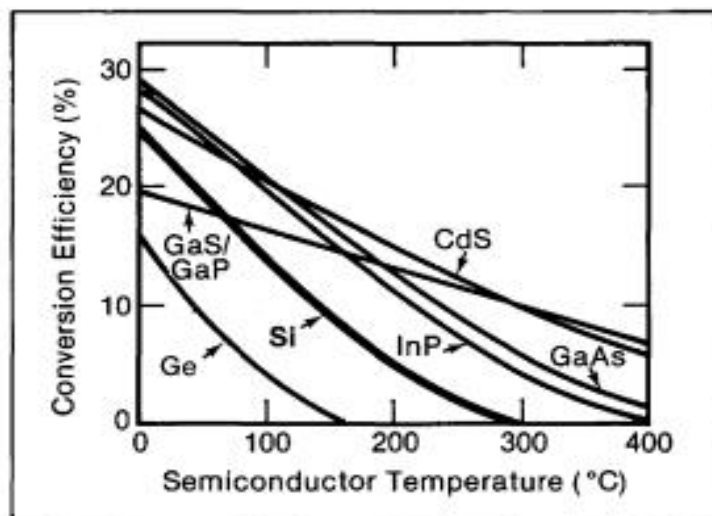

Figure 4-7: Solar cells' efficiency versus temperature for various materials (Source: SERI, 1981).

Our study recorded great discard between the ambient temperature and the panels walls temperature (**figure 4-8**). We note that before the sunrise, the modules and the ambient temperatures are the same. But with solar radiation increase, the temperature of panels walls warms up to 12 to 16°C above the ambient temperature which is around 30 to 60°C. of course, this will lead to an efficiency loss.

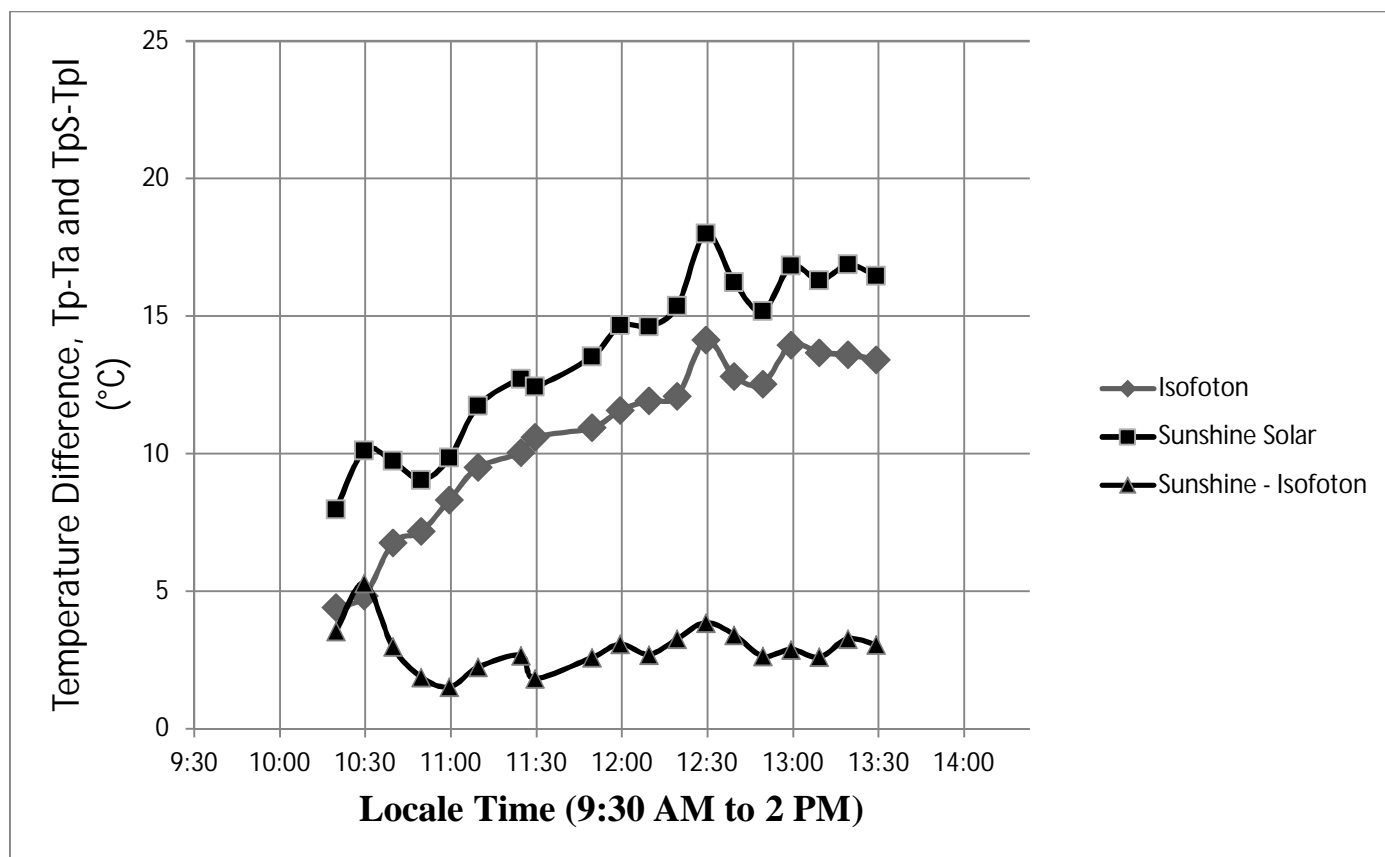

Figure 4-8: Differences between Ambient and Panels Walls Temperatures.

In **figure 4-9**, we note that the difference between ambient and panel wall temperature is proportional to the solar radiation with a high correlation of 0.8 to 0.9. This means that the warming stems from the absorption and dissipation of solar heat. On the other hand, we note that the two (2) types of modules behave differently in the absorption and dissipation of solar heat (one warms up higher than the other).

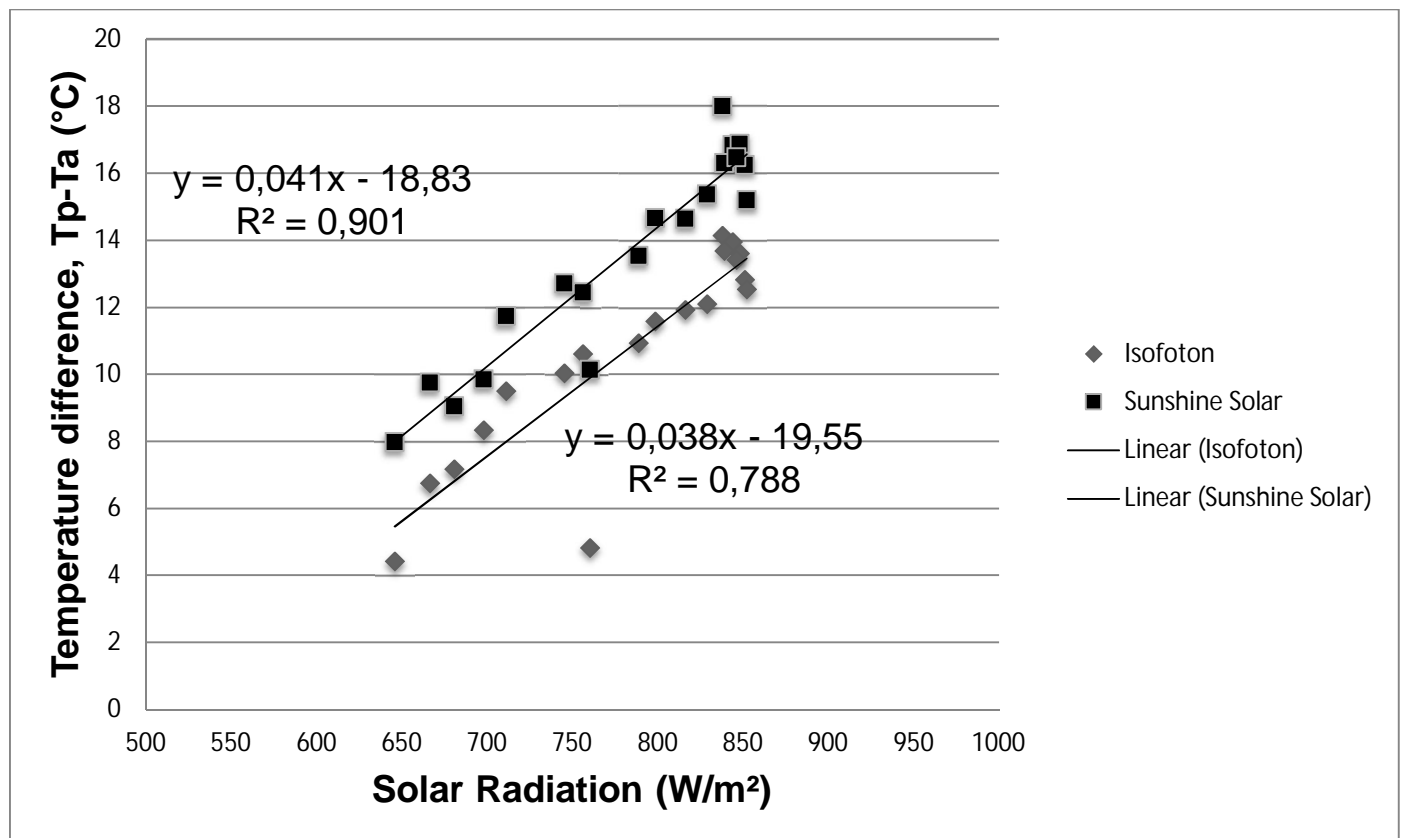

Figure 4-9: Temperature discards between the wall temperatures of the panels (Isofoton and Sunshine Solar) and the ambient temperature versus solar radiation

#### 4.1.2. Pump Performances

##### a) Pump Efficiency

While studying the data provided by the manufacturer in **Figure 3-5**, we noticed that for each pumping height, there is a crest power for which the pump efficiency is optimum. This can be noticed in **Figure 4-10** for a pumping height of 30 m, where the efficiency varies from 20% to 40% according to the used crest solar power.

One can even chart the optimum pump efficiency as a function of the solar power, as it is reported in **Figure 4-11**. Thus, we deduce that for a pumping height of 20 m, which is our case of study, the optimum efficiency is met for a solar power of less than 200  $W_p$ .



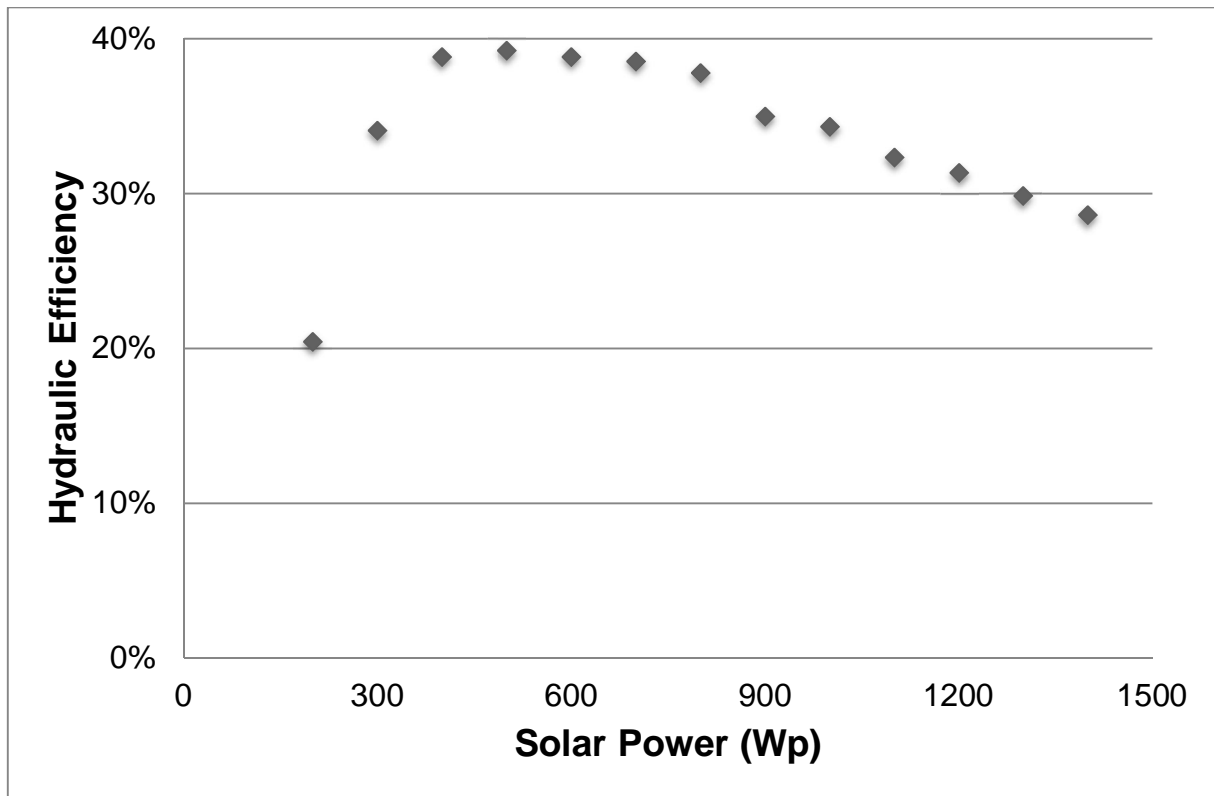

Figure 4-10: Optimum solar power for a pumping height 30 m

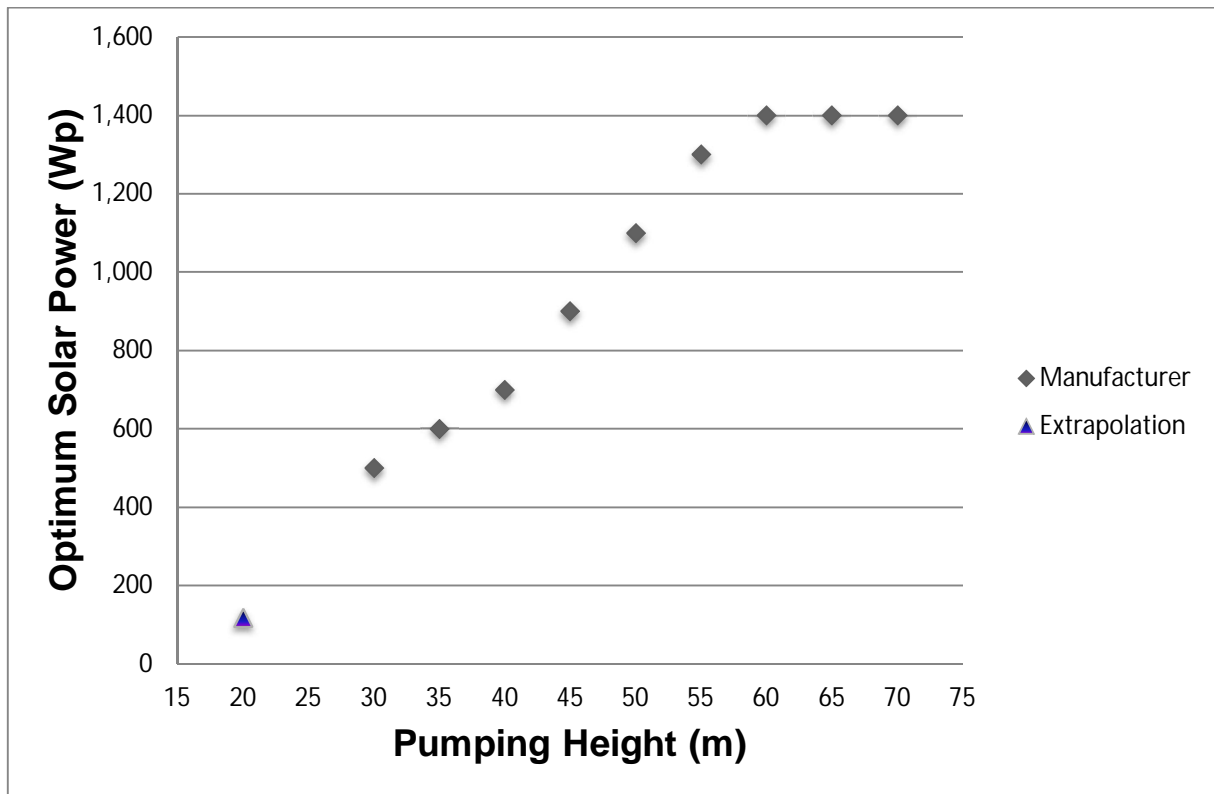

Figure 4-11: Optimum solar power according to the pumping height

In **Figure 4-12**, one can notice that the variation of the hydraulic efficiency with the pumping height is almost linear in the ranges of 30 to 45 m and 50 to 65 m. The parameters of the correlation in the first range are given in **Table 4-5**. Thus, the extrapolation of the pumping height (which is 20 m in our study) in accordance with the data of **Table 4-5**, lead to a hydraulic efficiency which matches with our measurement with an uncertainty less than 4 %.

Table 4-5: Parameters of the hydraulic efficiency in the range of 30 to 45 m height

Number of Data	Constant a	Constant b	Correlation R <sup>2</sup>
4	$6.11 \cdot 10^{-3}$	0.119	0.995

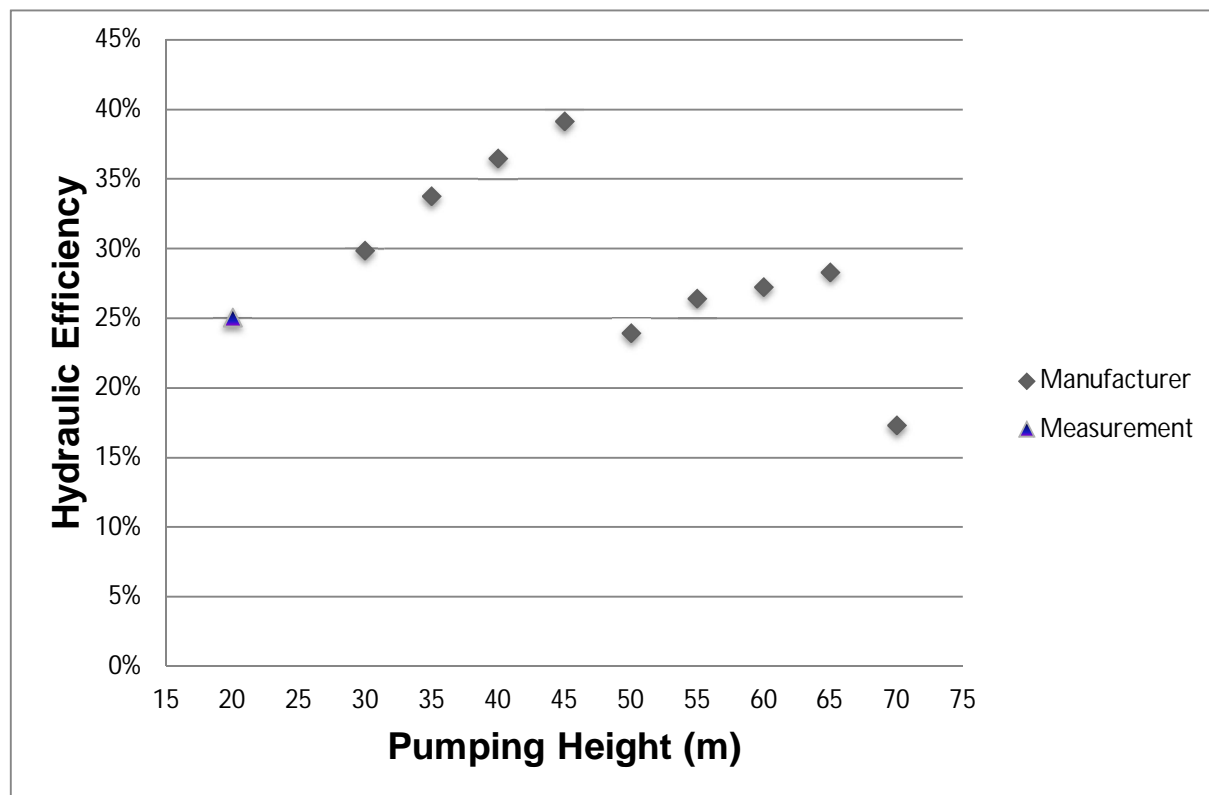

Figure 4-12: Measured and given (by manufacturer) efficiencies of the pump

### b) Pump Impedance

**Figure 4-13** presents the electrical characteristics of the pump, in which we noticed that the I-V curve is almost linear with correlation coefficients higher than 0.95. Thus, a linear model is proposed in **Equation (33)**. **Table 4-6** reports the pump impedance linear model constant for two experimental days.

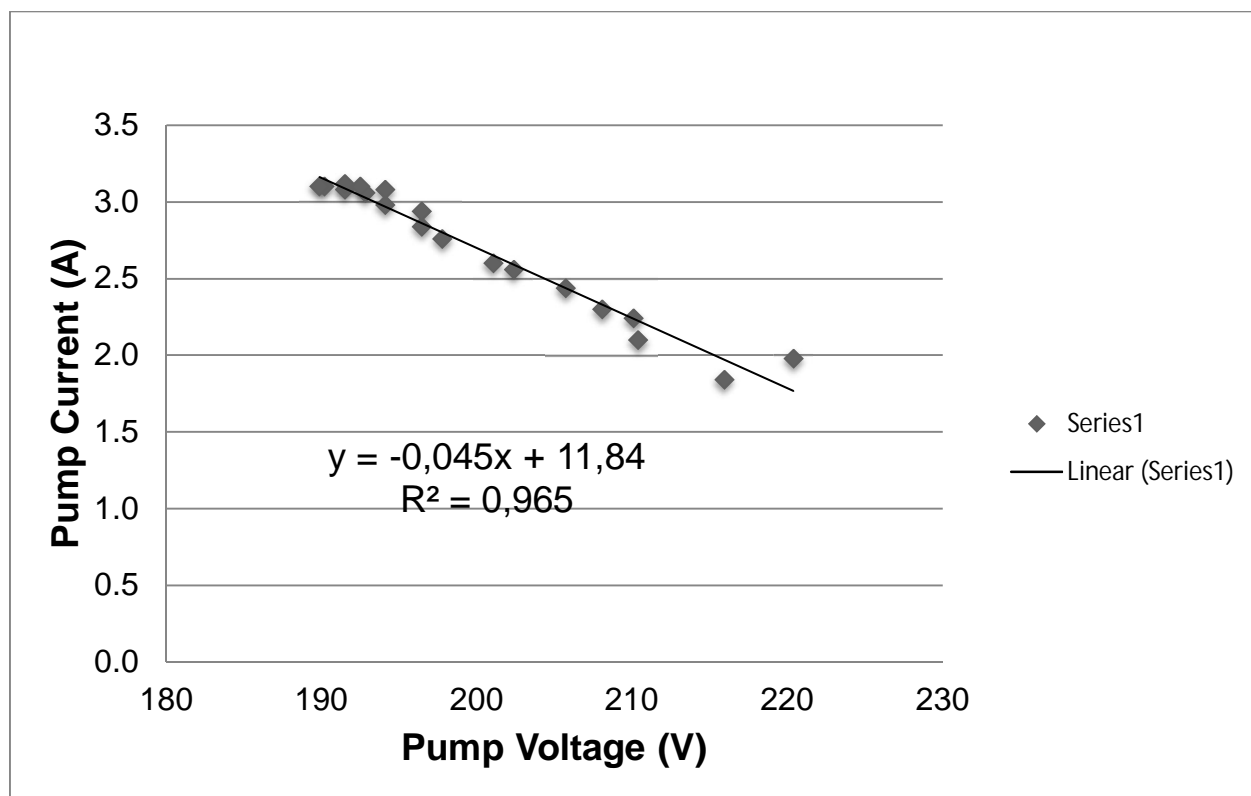

Figure 4-13: Electrical characteristic of the pump, I-V curve

$$I = aV + b \quad (33)$$

Table 4-6: Pump impedance linear model constants

Date	Number of Data	Constant a	Constant b	Correlation R <sup>2</sup>
16/12/2017	19	-0.045	11.840	0.965
19/12/2017	14	-0.035	9.965	0.958
<b>Average</b>		<b>-0.040</b>	<b>10.902</b>	

#### 4.1.3. Battery Performances

The main characteristics of the batteries are reported in **Table 4-7**.

Table 4-7: Technical characteristics of the batteries (See Table 3-7 and Appendix C)

	Characteristic Parameters	Value
Provided	Manufacturer	Isòfoton
	Type	Sealed Lead BT200 – 12 HC
	Nominal Voltage	12 V
	Capacity	200 Ah
	Cyclic use	14.4 – 15.0 V
	Standby use	13.5 – 13.8 V
	Initial current	Less than 50 A
Completed (Appendix C)	Plate sealed battery	Tubular with Lead – ca alloy
	Lifespan for PV applications	8 – 10 years
	Energy efficiency	> 90%
Evaluated	Number of batteries	6

The right capacity of the battery is given by **Equation (27)**. But its application requires the data of **Table 4-8**. Thus, the battery capacity should be 1,005 Ah. The effective battery capacity is higher than the evaluated one. In fact, it is 1,200 Ah, which represents 119 % above of the required battery capacity.

Table 4-8: Parameters required for the evaluation of the battery capacity

N°	Parameter	Value	Reference
1	Daily energy need	5 790 Wh/day	<b>Table 3-5</b>
2	Battery efficiency	higher than 90 %	<b>Table 4-7</b>
3	Battery nominal voltage	12 V	<b>Table 3-7</b>
4	Battery depth of discharge (DOD)	80 %	Unspecified
5	Number of autonomy days	1.5	

In spite of the good dimensioning of the generator (battery capacity 119 % higher than the needed and panel up to 45 % of the required crest installed power), we notice that, from **Figures 4-14** and **4-15**, the batteries are already worn out. The voltage drops to 10 V as soon as the sun set or when solar radiation is almost nil.

No indication has been given by the manufacturer about the lifespan of the battery, but from literature, it is specified that the lifespan for solar photovoltaic application of Isòfoton battery is 8 to 10 years (**Table 4-7**).

This can be explained by the way that the batteries have been connected to the inverter without passing through the converter (charge controller) as reported in **Figure 1-14 (Abdelkader et al., 2010)**. The effective connection of the system is summarized in **Figure 4-16**. By acting this way, the converter cannot protect the batteries from deep discharge. As specified in **Table 3-9**, this inverter has not any build-in switchover, nor built-in charger and nor build-in solar controller.

As reported in **Section 1.3.7. b)**, a converter is an electrical device that adjusts direct current (DC) voltage output either up or down from the input level. In many cases, these DC-to-DC converters can help regulate the amount of DC energy running through the system. This means that everything in the system beyond the controller — battery banks, inverters, and the like — receive a more consistent current.

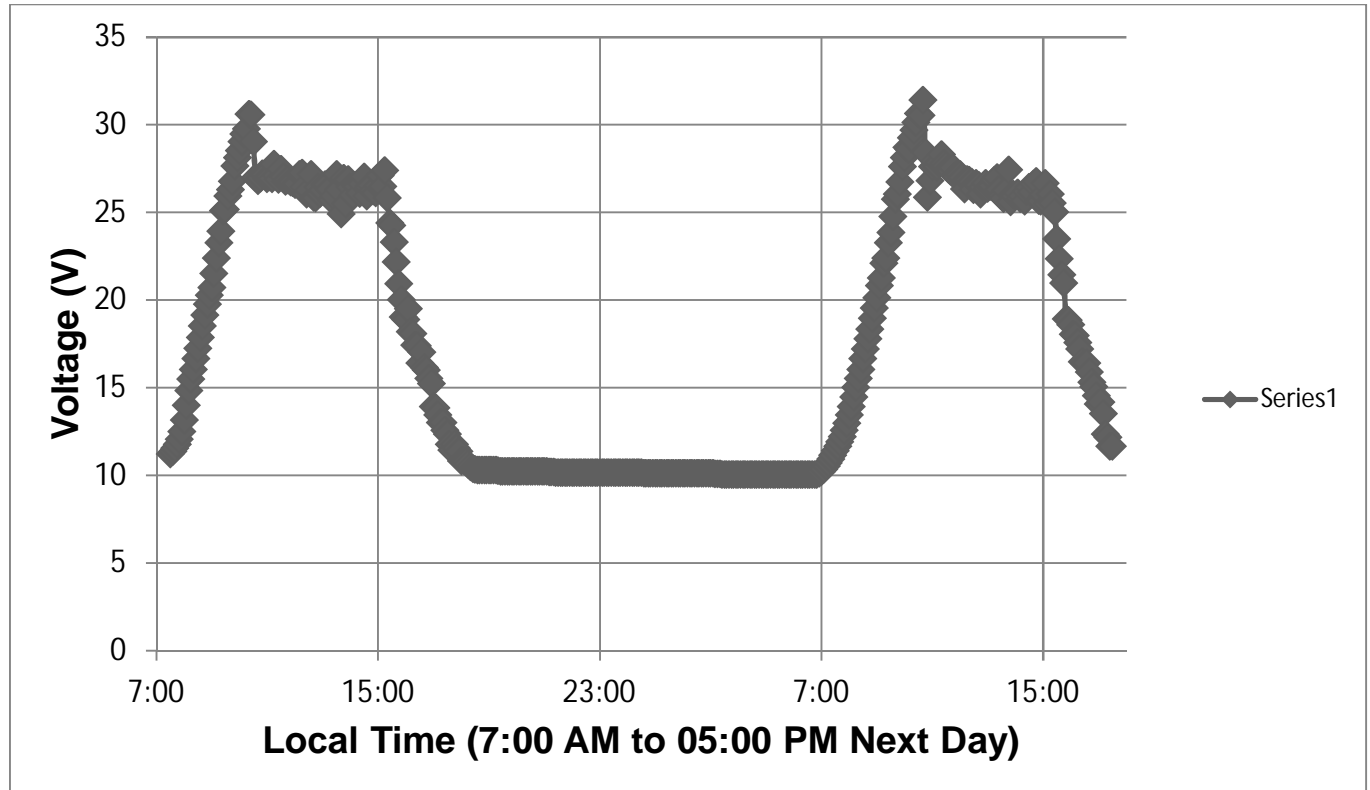

Figure 4-14: Variation of the battery voltage by night and daytime (10-11/11/2017)

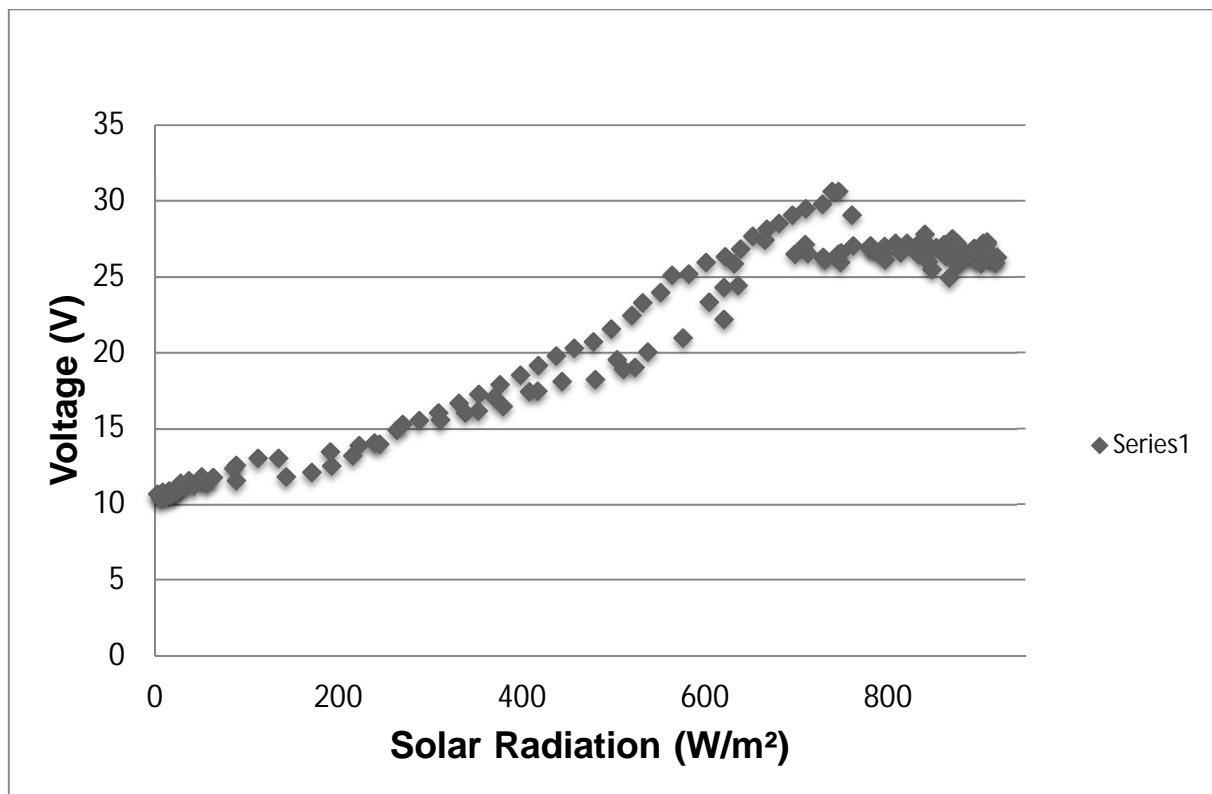

Figure 4-15: Variation of the battery voltage with solar radiation (10/11/2017)

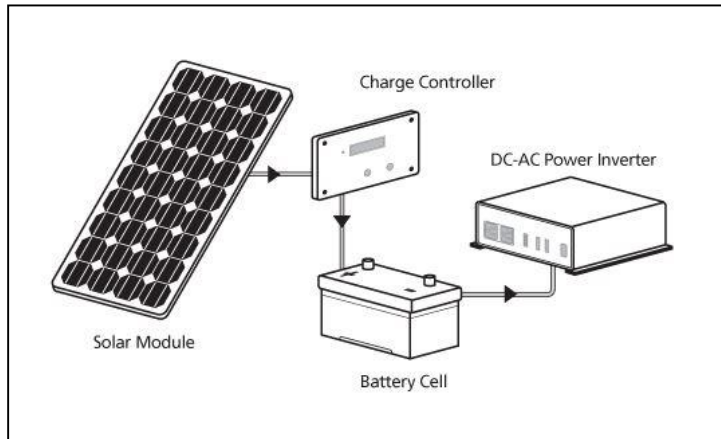

Figure 4-16: Scheme of the effective connection of the system (Source: <http://motorhomeadvantage.com/rv-solar/>)

#### 4.1.4. Inverter Performances

The right nominal power of an inverter is given by **Equation (26)**. But the application of this equation requires the receiver's power reported in **Table 4-9** (i.e., 1 590 W). Thus, the nominal power should range from 1.52 kW to 2.29 kW. As specified in **Section 3.2.2 f**, the effective nominal power of the present inverter is unknown.

As the batteries are worn out, we have not been able to evaluate the efficiency of the inverter, since the nominal input voltage of 12 V is no longer met (**Figure 4-22**). In another hand, special measurements are necessary to evaluate the output current of the inverter, since the logger does not measure alternative current data. Even if the efficiency of the inverter is evaluated for a given functioning power, the latter cannot be reported to the nominal power.

Table 4-9: Determination of the required inverter's power

Receiver' Power	1 590 W	
Value of factor k	2	3
Inverter's Power	3 180 W	4 770 W

#### 4.1.5. Charge Controller Performances

As stated in **Section 1.3.8 e**), the nominal voltage of the regulator should be equal to the nominal voltage of the PV generator, i.e., 12 V. Its current capacity should be equal to the maximum current of charge from the PV panel and to the maximum current of discharge from the receivers. **Table 4-10** provides the details about the determination of the charge controller parameters. Thus, the technical characteristics of the charge controller, reported in **Table 3-8**, comply with the requirement of **Table 4-10**, with a maximum current rating (solar and load currents) of 60 A.

Table 4-10: Determination of the required charge controller parameters

	Nominal Voltage	Power	Current
Generator, DC	12 V	600 Wp	50 A
Electrical Load, DC	12 V	762 W	64 A

In the other hand, **Table 3-8** reports about a minimum interrupting current rating of 75 A. With this datum, it cannot be explained why the inverter has not been connected to the charge controller thus leading to the destruction of the batteries' capacity.

## 4.2. Socio-Economic Study

### 4.2.1. Households Surveys

As above-mentioned, the results come from the only Kobadjé community. From 101 people interviewed, about 89% are men. The study shows that roughly 86% of people surveyed live in houses made up with clay. The results revealed that the majority of interviewees are employees (49.5% of them) and have the greatest income (See **Appendix F**). Notice that for men, there are 79 heads of the household against 6 for women. However, 51.5% of people surveyed earn between 2,000 to 5,000 CFA a day. In 2008, only a very handful of surveyed population (1%) have started using PV technologies; the number of users have grown rapidly. For instance, in 2014 about 0.2% of the sample population have started using PV technologies. However, before purchasing PV panels they have used in the past the commonly source for lighting in Niger's villages, kerosene (49.5%),

but also diesel generator (7.9%) and batteries for torch (51.5%). The village is supplied in water by a diesel generator and everybody buy water at the faucet at 25 F CFA per 25 liters. The pump works twice a day. People spend per day between 25 to 500 F CFA in buying water.

According to the results of the survey, almost all the interviewees (97%) have adopted PV technologies; this can be justified since the village is off-grid and is also an important commercial place. TV, laptops, phones, radios, movies home, LED lamps and refrigerators are technologies using PV panels that we can encounter in Kobadjé according to the interviewees.

The frequency of PV technology utilization during a day is about 97%. Only 3% of persons use kerosene for lighting.

The interviewees have invested between 15,000 to 275,000 CFA (23-420 €) in order to get solar PV technologies. The investment came from three (3) sources: incomes/savings, tontine (mutual loan); and loan (**Table 4-11**).

*Table 4-11: Sources of financing, purchase, and installation of PV technologies.*

Source	Percentages
Incomes/Savings	78,2%
Tontine (mutual loan)	13,9%
Loan	7,9%
Total	100%

In order to capture the reason of using solar PV, nine (9) criteria were presented to the interviewees (**Figure 4-17**). The results indicate that the overwhelming majority of respondents argue that the main reason was financial, about 94.1% make such statement, although 69.3%) of them also highlighted the comfort that this technology bring.

Indeed, 100% of persons interviewed confirmed that they used PV technologies for lighting which is characteristic of Niger's villages according to some studies (SNV, 2012, 2014). Nonetheless, one other relevant reason for them to get PV technologies for lighting is for educational purpose in order to increase the success rate of their children even if only 38.6 % of the interviewees concluded for this last reason.



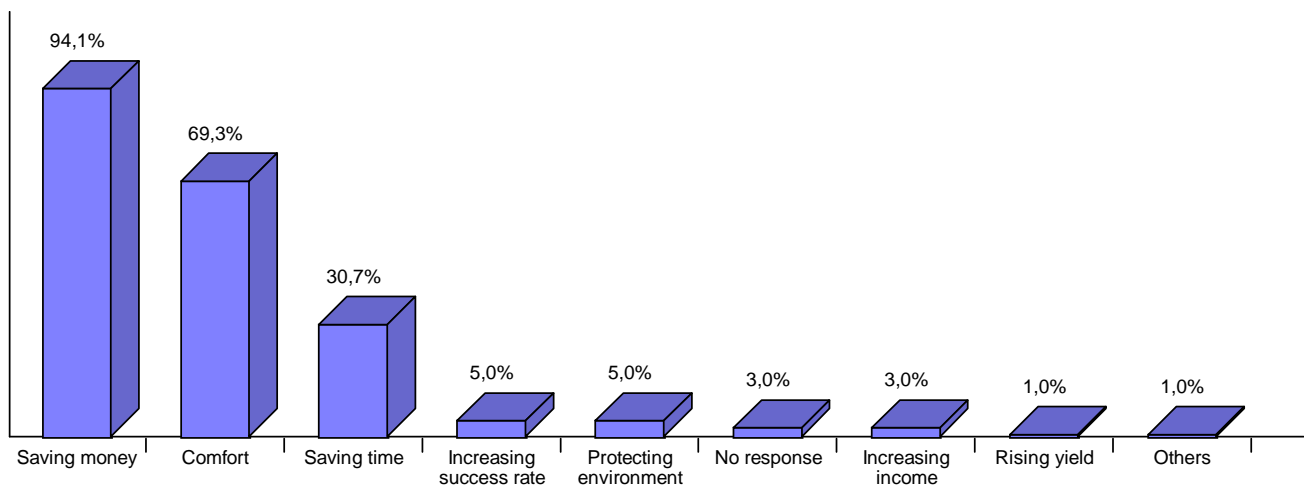

Figure 4-17: Reasons for using Solar PV

Despite the fact that PV panels are environmentally friendly, only 5% of persons interviewed have pointed out this reason (**figure 4-17**). Nevertheless, 58.4% of persons (**figure 4-18**) affirmed that there are some negative impacts on the environment and social life like smokes (kerosene, diesel generator) and noise (diesel generator) but also positive impact, no pollution (solar PV panels).

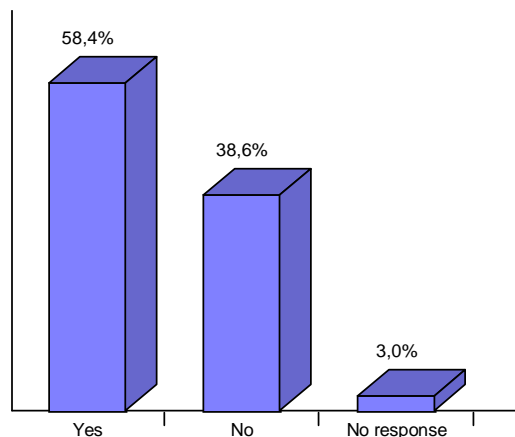

Figure 4-18: Impacts perceptions

On the economic level, only 4% of the interviewed assumed that they earn money after installing PV technologies because the solar PVs are mostly installed for the domestic purpose. Actually, 3% of them increase their income either by charging neighbors' phones or by lighting goods that they sell.

The figure below (**figure 4-19**) shows how having PV panels changes the interviewed people life.

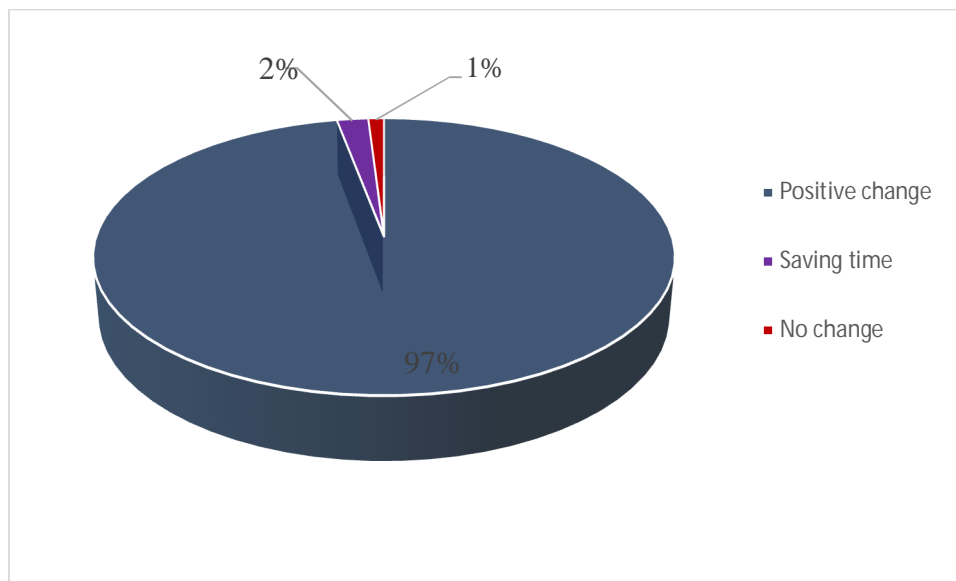

Figure 4-19: PV technologies impacts' perceptions

Ninety percent (96%) of surveyed people were agreed to invest more in PV systems when possible. However, 2% did not agree, putting forward batteries issues and the expensiveness of PV systems. The main reason why they agree is that they find solar PV technology more economic and comfortable (**figure 4-20**).

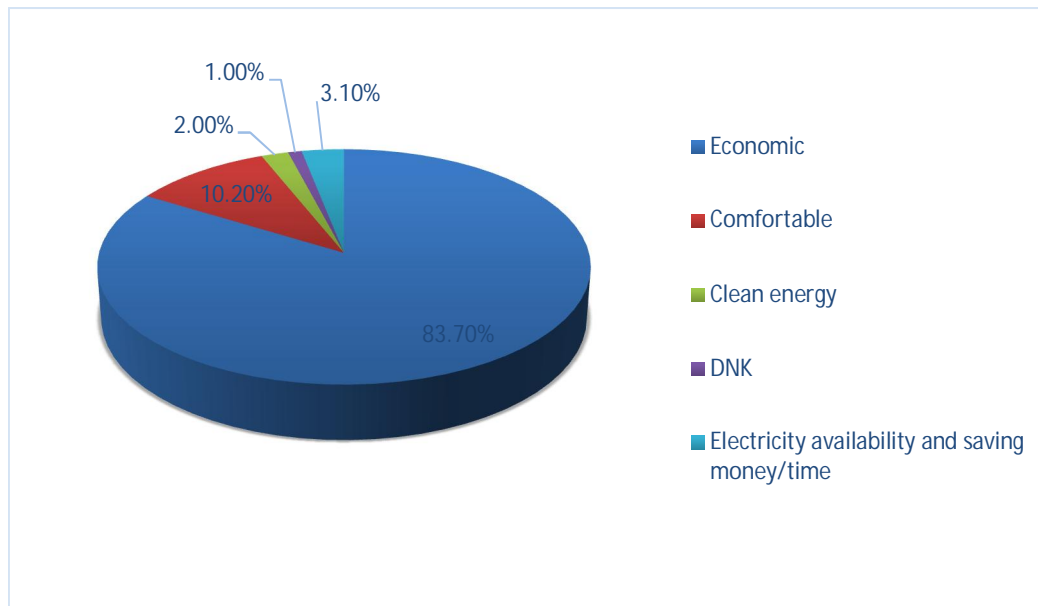

Figure 4-20: Reasons why persons will agree to invest in Solar PV systems

In terms of migration, all claim that nobody has left the village to go where there is electricity, on the contrary, the possibility of affording LED lamps allowed them to increase their activities.

### 4.2.2. Commercial Surveys

Based on the persons who invested in solar PV panels in order to do either business activity (refrigeration, lighting goods, sewing, etc.) or to sell electricity services (phones' charging, lighting), the graph below (**figure 4-21**) shows that from the of 90 persons concerned, 63.3% of the interviewees come from Kobadjé , while 36.7% from villages and hamlets around Kobadjé (Bololadié, Laoudou, Dianhoé, Finfetou, Piliki, Djankondi, Diagoga, Djobribé, Korantanga, Ouro Sawabé, Ouro Sabadjé, Tchelel Eda Debere, Ticko).

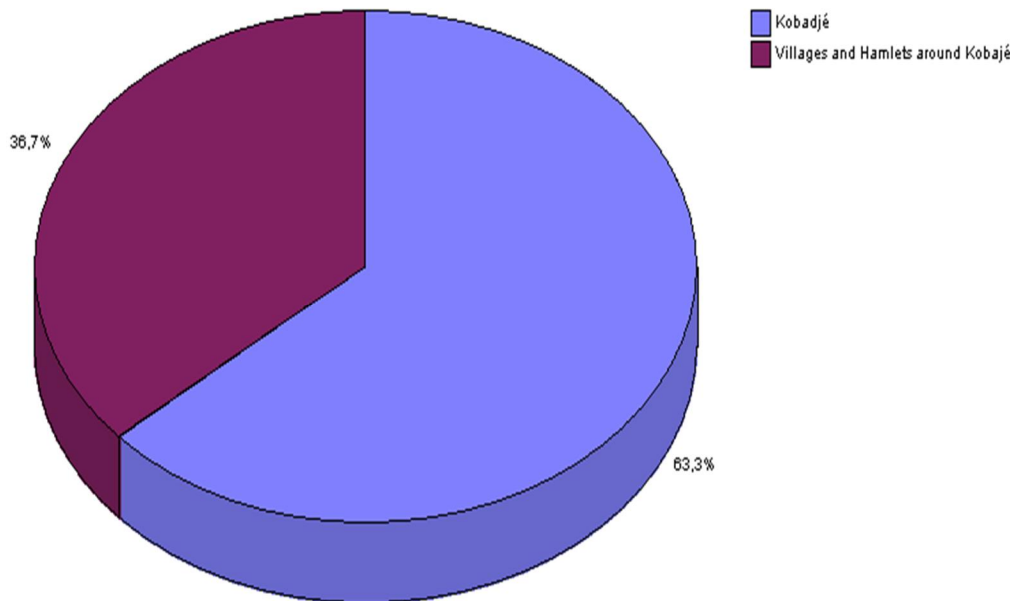

Figure 4-21: Surveyed villages repartition

The interviewees' interest for PV panels is due to the facts that PV panel is reliable, it allows them to do their commercial activities overnight, to make a profit but also to have the electricity at any time without paying any bill which makes it economic. Furthermore, they said that PV technology makes them feeling urbanized. Also, 96.7% agree and recommend to get PV panels technology because it does not first, emit any smoke like kerosene and then make a noise like diesel generator.

The interviewees are in the majority men (97.8%) and most of them own the PV systems (72:7%) (**figure 4-22**). They began installing PV panels since 2016 but most of them installed these systems in 2012 (**figure 4-23**). The principal sources of income came from business and farming (**figure 4-24**). Indeed, the electricity is used for the commercial purpose such as the charge of electrical equipment, home lighting, shops lighting, refrigeration, gas station, sewing machines, video games, cinema but also for gardening (water pump) and mechanic. Though 41.1% are sharing the electricity with neighbors free of charge or with cash. These last are invoiced 1,000 to 30,000 F CFA per month depending on the provided service. The PV systems can work during 5 to 24 hours per day (**figure 4-25**).

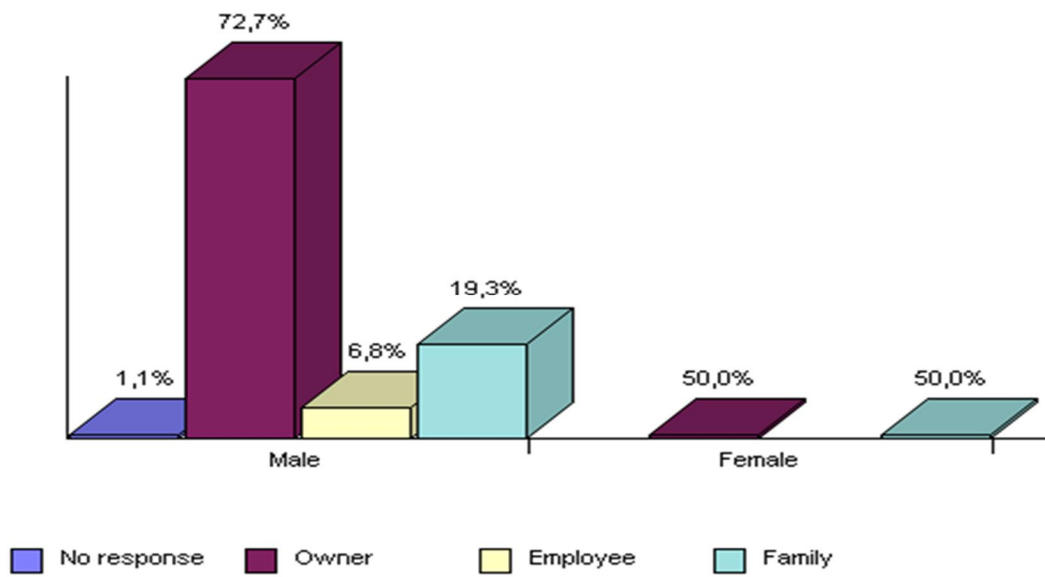

Figure 4-22: Gender and Interviewee repartition

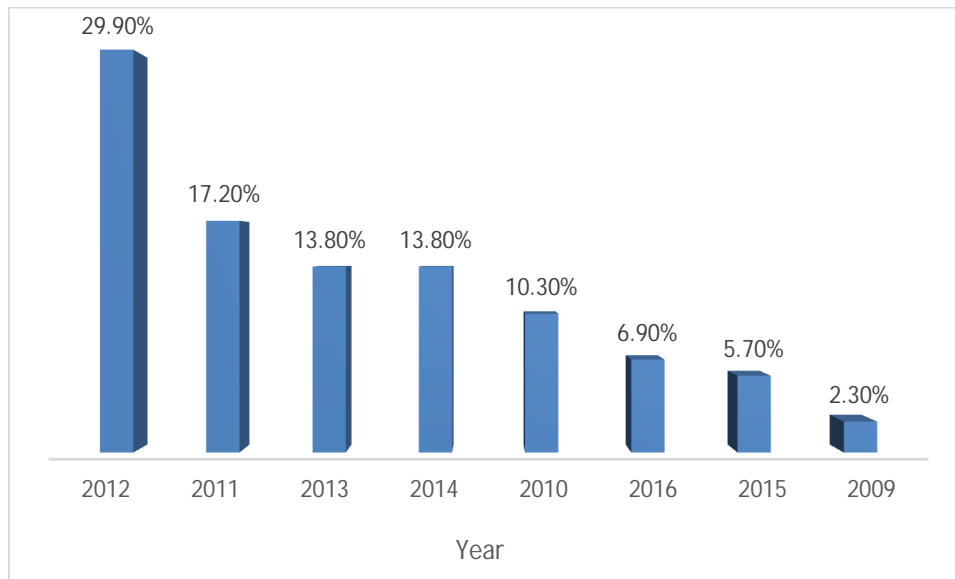

Figure 4-23: Year of PV Panels installation

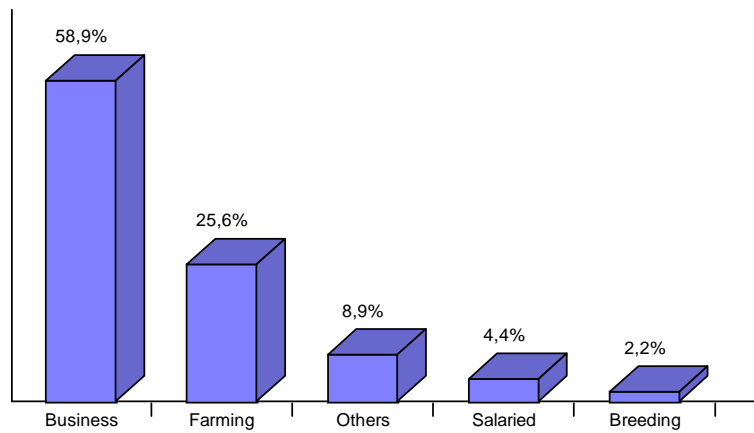

Figure 4-24: Income sources of interviewees.

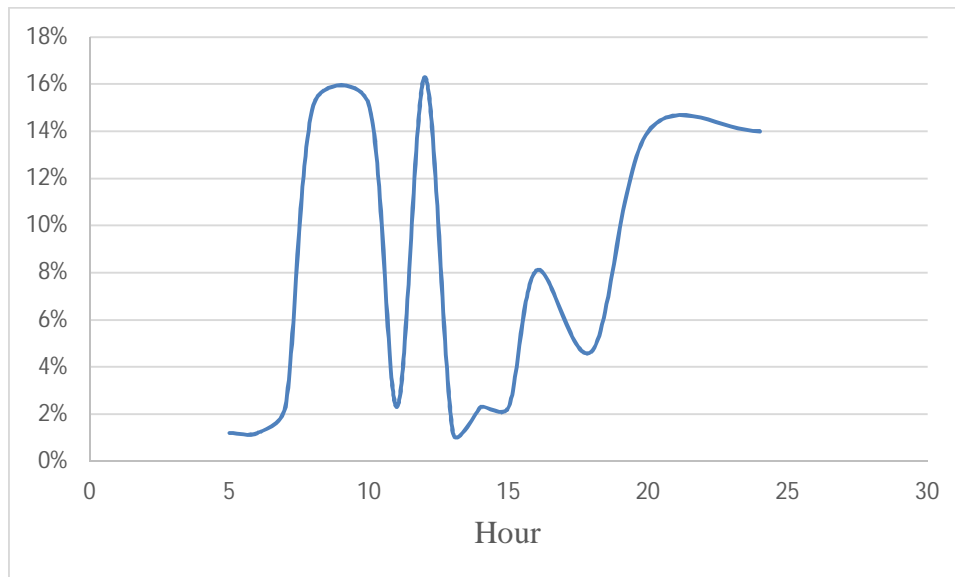

Figure 4-25: Working period of PV systems during a day.

On the 83 respondents, the investment varied from 37,000 F CFA (57€) to 1,250,000 F CFA (1,906€) and the sources of the investment come mostly from the sale of livestock (62.2%) as well as loan (22.2%) and others sources such as income, savings, tontine (30%). About 48% of the people interviewed said they spent between 1,000 and 40,000 F CFA for maintenance (dust cleaning, spare materials replacement). Although, more than a third of them have found the turnover excellent (**figure 4-26**).

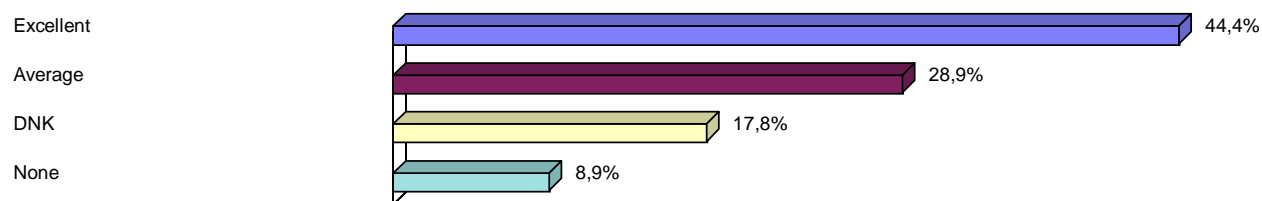

Figure 4-26: Turnover perception.

In short, 98.6% of these interviewed people affirmed that the technology is changing people life by:

- enlarging commercial and social activities in the village,
- making kids, teenagers, adults happy (video games, cinema),
- facilitating energy access (lighting) and communication (phones charge),
- allowing to keep food in the refrigerator.

## Partial Conclusion

This chapter presented the results and findings, first, of the parameters influencing the technical performance of PV systems under real climatic conditions in Sarando Bené, and then, the socioeconomic aspects of PV utilization in the village of Kobadjé.

Firstly, the results showed that when the solar radiation increases, the voltage of the solar panels moves away from values next to the maximum power output voltage to values around 13 V for the Isòfoton panels and to 19 V for the Sunshine solar ones. Thus, the performance ratio is respectively 8% and 5% (versus 12% and 17% as reported by the manufacturers) for Isòfoton and Sunshine solar panels. The study showed that there is a great discard between the modules wall temperature and the ambient temperature up to 12 and 16°C respectively for Isòfoton and Sunshine solar panels. The measured efficiency of the solar pump is 15%. However, the performance of such kind of pump could attain up to 25% for a water height of 20 m through an optimum sizing of 200 Wp. The findings showed also that the batteries worn out because of the wrong wiring. Thus, it was not possible to study the performances of the accessory devices such as inverter and charge controller.

Secondly, surveys showed that rural people even if poor, cared about electricity. They are aware that solar technology is impacting socially and economically people life. The surveyed people are ready to invest in solar PV panels if they can afford.

## GENERAL CONCLUSION

The conclusion of this study relates, first, to the parameters influencing the technical performance of PV systems under real climatic conditions in Sarando Bené, and then, the socioeconomic aspects of PV utilization in the village of Kobadjé and surroundings.

The first set of results showed that in the mixture of two (2) types of PV modules for the pumping purposes, these modules behave differently in supplying electricity to the solar pump. When the solar radiation increases, the voltage of the solar panels moves away from values next to the maximum power output voltage (17 V for each type of modules) to values around 13 V for the Isòfoton panels and to 19 V for the Sunshine solar ones. Thus, the performance ratio is respectively 8% and 5% (versus 12% and 17% as reported by the manufacturers for an optimal functioning point) for Isòfoton and Sunshine solar panels.

The study showed that there is a great discard between the modules wall temperature and the ambient temperature up to 12 and 16°C respectively for Isòfoton and Sunshine solar panels. On the other hand, the study showed that the discard between panels wall and the ambient temperature is proportional to the solar radiation and the two (2) types of modules behave differently in dissipating solar heat.

The measured efficiency of the solar pump is 15%. However, the performance of such kind of pump could attain up to 25% for a water height of 20 m (as it is the case in this study) through an optimum sizing of 200 Wp. The extrapolation of the pumping height which is 20 m in our study, led to a hydraulic efficiency which matches with our measurement with an uncertainty less than 4 %.

The batteries wore out just after 18 months (instead of 5 years usually) of utilization because of the wrong wiring of the charge controller. Thus, it was not possible to study the performances of the accessory devices such as inverter and charge controller.

The second set of results relates to a socioeconomic survey in the rural area of Kobadjé village and surroundings. They showed that rural people even if poor, cared about solar electricity. In this regard, more than 99% of people use daily solar electricity for their household or commercial purposes. This shows how important is solar electricity in the improvement of rural population life (education, health, economy and so on). This means that even if the rate of electrification in Niger is very weak (less than 20%) due to solar energy, the real electrification rate is higher and not far from 99% in Kobadjé area.

### Completion

For the completion of the study, it is worthwhile to conduct the measurement of a solar panel photo current generation with solar radiation by studying the variation of the short-circuit current with solar radiation. Thus, we would have more accurate data for the characterization of the solar panel performances. The solar generator must be studied with new and functional batteries in order

to discover the real performance of the charge controller, inverter, and battery itself. A more studied scheme would lead to higher performance for the solar pump.

For the case of social economic impacts study, it is worthwhile to determine the power of the solar equipment used by the population. This will help in sizing the energy need of rural population in solar equipment in Niger and by extension to the Sahel regions. On the other hand, it is necessary to extend the study to a whole village population.



## BIBLIOGRAPHY

A. Virtuani, E. Lotter, P. M. (2006). Influence of the light source on the low irradiance performance of Cu (In: Ga) Se<sub>2</sub> solar cells. *Solar Energy Materials and Solar Cells*. 90(14), 2141–9.

Abdelkader, M. R., Al-Salaymeh, A., Al-Hamamre, Z., and Sharaf, F. (2010). A Comparative Analysis of the Performance of Monocrystalline and Multi-crystalline PV Cells in Semi-Arid Climate Conditions: the Case of Jordan. *Jordan Journal of Mechanical and Industrial Engineering*, 4(5).

Bharat Raj Singh and Onkar Singh. (2012). Global Trends of Fossil Fuel Reserves and Climate Change in the 21st Century, *Fossil Fuel and the Environment*, Dr. Shahriar Khan (Ed.), ISBN: 978-953-51-0277-9, InTech, Available from: <http://www.intechopen.com/books/fossil-fuel-and-the-environment/global-trends-of-fossil-fuel-reserves-and-climate-change-in-the-21st-century>

BMZ. (2016). Die Kraft der Sonne nutzen. Retrieved April 28, 2017, from [http://www.bmz.de/de/themen/energie/erneuerbare\\_energien/solar/index.html?PHP](http://www.bmz.de/de/themen/energie/erneuerbare_energien/solar/index.html?PHP)

SESSID=d710801c386dda90f8c69c0dafc8281c

Bonkaney, Abdoulatif, Madougou, Saïdou, Adamou, Rabani. (2017). *Journal of Renewable Energy*. (2017). 1-8. Doi 10.1155/2017/9107502

Brigand S., 2011, Installations solaires photovoltaïques : Dimensionnement, Installation et mise en œuvre, maintenance, Le Moniteur, Pp284

Buresch, M. (1983). *Photovoltaic energy systems design and installation*, Mc Graw-Hill Book Company, New-York, Pp347

Carl-Anton von Heyking, Tinoush Jamali Jaghdani. (2017). Expansion of photovoltaic technology (PV) as a solution for water energy nexus in rural areas of Iran; comparative case study between Germany and Iran. *Discussion Papers*.

CNES, National Center for Solar Energy, 2015, Internal report, Tome I; II.

Dajuma, Alima, Yahaya, Saleye, Touré, Siaka, Diedhiou, Arona, Adamou, Rabani, Konaré, Abdourahamane, Sido, Mariama, and Golba, Michel. (2016). Sensitivity of Solar Photovoltaic Panel Efficiency to Weather and Dust over West Africa: Comparative Experimental Study between Niamey (Niger) and Abidjan (Côte d'Ivoire). *Computational Water, Energy, and Environmental Engineering*. (05). 123-147. Doi 10.4236/cweee.2016.54012

Darwish, Zeki Ahmed, Kazem, Hussein A., Sopian, K., Alghoul, M. A. Chaichan, Miqdam T. (2013). Impact of Some Environmental Variables with Dust on Solar Photovoltaic (PV) Performance: Review and Research Status. *Researchgate.Net*. Volume 7. 152-159

Didier Mayer, Michael Heidenreich, Performance Analysis of Stand Alone PV Systems From A Rational Use of Energy Point of View, 3rd World Conference (IEEE) on Photovoltaic Energy Conversion, May 11-18, 2003 Osaka. Japan

Dupré, Olivier, Vaillon, Rodolphe, Green, Martin A. (2017). Thermal Behavior of Photovoltaic Devices. Retrieved from <http://link.springer.com/10.1007/978-3-319-49457-9>

Foster R, Majid G, Cota A. (2014). A test book of solar energy. Renew Energy Environ.

Fraunhofer ISE 2014, [https://en.wikipedia.org/wiki/Solar\\_inverter](https://en.wikipedia.org/wiki/Solar_inverter)

G. N. Tiwari and Swapnil Dubey, Tiwari, G. N., Swapnil, Dubey. (2010). Fundamentals of Photovoltaic Modules and their Applications. Pp423.

Gary, C., Billman, L., And, and Adcock, R. (1995), Photovoltaic Fundamentals, National Renewable Energy Laboratory, Pp63

IEA. (2011). Solar Energy Perspectives.

H. A. Kazem, M. T. Chaichan, I. M. Al-shezawi, H. S. Al-saidi, H. S. Al-rubkhi, K. Al-sinani, and A. H. A. Al-waeli. (2012). Effect of Humidity on the PV Performance in Oman, 02(04), 29–32.

H. Hottel and B. Woertz. (1942). Performance of flat plate solar heat collectors. Transactions of American Society of Mechanic Engineering, 64, 91–104. INTERNATIONAL RENEWABLE ENERGY ASSESSMENT. 2013. "Niger, renewable readiness assessment." book.

H. Qasem. (2013). Effect of accumulated dust on the performance of photovoltaic modules. PhD, Loughborough University Institutional Repository. Retrieved from <https://dspace.lboro.ac.uk/2134/11735>

Hussein, H. M S, Ahmad, G. E., El-Ghetany, H. H. (2004). Performance evaluation of photovoltaic modules at different tilt angles and orientations. Energy Conversion and Management. (45). 2441-2452. Doi 10.1016/j.enconman.2003.11.013

Ibrahim Dincer. (1999). Renewable energy and sustainable development: a crucial review. Renewable and Sustainable Energy Reviews. 4 (2000). 157–175

IEA-PVPS. (2014). PV Systems for Rural Health Facilities in Developing Areas - A completion of lessons learned. 1-56.

IPCC. (2007). "Climate Change 2007 Synthesis Report."

IPCC. (2012). "IPCC Special Report on Renewable Energy Sources and Climate Change Mitigation"

IRENA. (2013). Niger RRA, 2013.

- IRENA. (2014). *The Socio-economic Benefits of Solar and Wind Energy*.
- Jakhrani, Abdul Qayoom, Othman, Al-khalid, Rigit, Andrew R H, Samo, Saleem Raza, Ahmed, Shakeel. (2012). Estimation of Incident Solar Radiation on Tilted Surface by Different Empirical Models. *International Journal of Scientific and Research Publications*. (2). 15-20.
- Jakhrani, Abdul Qayoom, Samo, Saleem Raza, Rigit, Andrew Ragai Henry, Kamboh, Shakeel Ahmed. (2013). Selection of models for calculation of incident solar radiation on tilted surfaces. *World Applied Sciences Journal*. (22). 1334-1343.
- Jan Rordorf. (2011). Opportunities for a sustainable rural energy supply through renewable energies in developing countries: Socio-economic feasibility study of the operation of a multi-functional platform in the village of Laila, Tanzania on locally produced biofuels.
- Karekezi, Stephen, and Ranja. 1997. *Renewable Energy Technologies in Africa*. Zed Books.
- Karekezi, Stephen, Waeni Kithyoma, and Energy Initiative. 2003. "Renewable Energy Development." Pp. 2–4 in workshop on African Energy Experts on Operationalizing the NEPAD Energy Initiative, June.
- Karekezi, Stephen. 2002. "Renewables in Africa - Meeting the Energy Needs of the Poor." *Energy Policy* 30(11-12):1059–69.
- Kenichi Imai: The International Centre for the Study of East Asian Development, Japan and Debajit Palit: The Energy and Resources Institute, India. 2013. "Impacts of Electrification with Renewable Energies on Local Economies: The Case of India's Rural Areas".
- Khan S.-A., Azad A. K. M. A. M. (2014). Social Impact of Solar Home System in Rural Bangladesh [...], *IAFOR Journal of Sustainability. Energy and the Environment*. 1(1). 5-22.
- Kumar Panjwani, Manoj, Bukshsh Narejo, Ghous. (2014). Effect of Humidity on the Efficiency of Solar Cell (photovoltaic). *International Journal of Engineering Research and General Science*. (2). 499-503.
- Loutzenhiser, P. G., Maz, H., Felsmann, C., Strachan, P. A., Frank, T., and Maxwell, G. M. (2007). Empirical validation of models to compute solar irradiance on inclined surface building energy simulation. *Solar Energy*, 81, 254–267.
- M. A. Bashir, H. M. Ali, M. Ali, and A. M. Siddiqui. (2013). An experimental investigation of performance of photovoltaic modules in Pakistan. *Thermal Science*, doi:10.2298/TSCII130613134B.
- M. Mani and R. Pillai. (2010). Impact of dust on photovoltaic (PV) performance: research status, challenges and recommendations. *Renewable and Sustainable Energy Reviews*, 14, 3124-3131.
- M. Noorian, I. Moradi and G. Kamali. (2008). Evaluation of 12 models to estimate hourly diffuse irradiation on inclined surfaces. *Renewable Energy*, 33(6), 1406–1412.

M. Pagliaro, R. Ciriminna, and G. Palmisano. (2008). "Flexible solar cells." *ChemSusChem* 880-891. V. Quaschnig. (1996). *Simulation der Abschattungsverluste bei solarelektrischen Systemen*. Köster. Koster.

Mahmoud, M., and Ismail, N. (1990). Analytical and graphical methods for determination of solar cell parameters and investigations of shadowing effect. *International Journal of Solar Energy*, 9, 179–92G.

Marwan M. M. (2006). Transient analysis of a PV power generator charging a capacitor for measurement of the I–V characteristics. *Renewable Energy*, 31, 2198–2206

Nimmo, B. R. U. C. E, and S. A. Said. (1981). "Effects of dust on the performance of thermal and photovoltaic flat plate collectors in Saudi Arabia-Preliminary results." *Alternative energy sources II*, Volume 1. 145-152.

Q. Jakhrani, A. K. Othman and S; R. Samo. (2011). Comparison of Solar Photovoltaic Module Temperature Models, 14, 1–8.

R. Hill. (1999). "Prospects for Photovoltaic." *energy world* 208: 8-11.

REN21. 2012. *RENEWABLES, 2012*. book, Paris: Global Status Report.

Rodrigues, E. M. G., Melício, R., Mendes, V. M. F., and Catalão, J. P. S. (2011). Simulation of a Solar Cell considering Single-Diode Equivalent Circuit Model. *International Conference on Renewable Energies and Power Quality*, Spain, 13–15. Retrieved from <http://icrepq.com/icrepq'11/339-rodrigues.pdf>

Roger J.A., 1993, *Notions de base sur les convertisseurs photovoltaïques*, *Energie Solaire Photovoltaïque*, Volume 1, *Physique et Technologie de la conversion photovoltaïque*, Ellipses UNESCO, Pp 238

S Szabó, K Bódis, T Huld<sup>1</sup> and M Moner-Girona. (2011). Energy solutions in rural Africa: mapping electrification costs of distributed solar and diesel generation versus grid extension. [Environmental Research Letters](#). [Volume 6](#). Number 3.

S. Mekhilef, R. Saidur, and M. Kamalisarvestani. (2012). Effect of dust, humidity and air velocity on efficiency of photovoltaic cells. *Renewable and Sustainable Energy Reviews*, 16, 2920–2925. <http://doi.org/10.1016/j.rser.2012.02.012>

S. said, A. Massoud, M. Benammar, and S. Ahmed. (2012). "A Matlab/Simulink based photovoltaic array model employing SimPowerSystems toolbox." *journal of energy and power engineering* 6: 1965-1972.

Samuel V. Brown, David G. Nderitu, Paul V. Preckel (P.I.), A. Douglas J. Gotham (Co-P.I.), Benjamin W. Allen. (2011). *Renewable Power Opportunities for Rural Communities*. United States Department of Agriculture. Retrieved from <https://www.usda.gov/oce/reports/energy/RenewablePowerOpportunities-Final.pdf>

Smith, A. S., and Sedra, K. C. (2006). *Microelectronic Circuits*. Oxford University. Ugwuoke, P. E., and Okeke, C. E. (2012). Performance Assessment of Three Different PV Modules as a Function of Solar Insolation in South Eastern Nigeria. *International Journal of Applied Science and Technology*, 2(3).

SOLAR, R. 2014. "stratified energy access in Niger." SNV 61: 10-15.

Tiwari, N., 2002, *Solar Energy, Fundamentals, Design, Modelling and Applications*, Narosa Publishing House, pp. 525.

Urmee, T., Harries, D., & Holtorf, H.-G. (2016). *Photovoltaics for rural electrification in developing countries: a road map*. Cham, Switzerland: Springer International Publishing AG Switzerland.

## WEBOGRAPHY

- [1]. <http://www.gosolarcalifornia.ca.gov/about/gosolar/california.php> consulted 01/15/2017.
- [2]. [http://www.iea.org/publications/freepublications/publication/WEO2014\\_AfricaEnergyOutlook.pdf](http://www.iea.org/publications/freepublications/publication/WEO2014_AfricaEnergyOutlook.pdf)). IEA. 2014a. "Africa Energy Outlook." Retrieved 01/15/2017
- [3]. <http://www.ni.com/white-paper/7231/en/> Consulted 01/12/2017
- [4]. <http://www.samlexsolar.com/learning-center/solar-systems-basics.aspx>, consulted 01/18/2017.
- [5]. <http://www.snvworld.org/en/regions/africa/publications/stratified-energy-access-in-niger> SNV, Raach Solar. (2014). Stratified Energy Access in Niger. Retrieved April 30, 2017, from
- [6]. <http://www.solar-facts-and-advice.com/images/xcell-to-array.jpg.pagespeed.ic.8Mb-QYdCUx.jpg>
- [7]. <http://www.solar-facts-and-advice.com/images/xhow-solar-panels-used.jpg.pagespeed.ic.Ab1A5w0Stm.jpg> accessed on 22/01/2017
- [8]. [http://www.srmuniv.ac.in/openware\\_d\\_loads/u5Lecture-2.ppt](http://www.srmuniv.ac.in/openware_d_loads/u5Lecture-2.ppt) accessed on 06/01/2018
- [9]. <http://www.vasun.org/2015/11/19/a-brief-history-of-solar-energy/> consulted 09/02/2018.
- [10]. <http://www.worldenergyoutlook.org/resources/energydevelopment/> accessed on 20/01/2017
- [11]. <http://www.worldenergyoutlook.org/resources/energydevelopment/>. IEA. 2014b. "World Energy Outlook." Retrieved 01/15/2017
- [12]. <https://commons.wikimedia.org/w/index.php?curid=519344> accessed on 20/01/2017
- [13]. [https://en.wikipedia.org/wiki/Photovoltaic\\_effect](https://en.wikipedia.org/wiki/Photovoltaic_effect)
- [14]. <https://firstgreenconsulting.wordpress.com/2013/01/05/case-study-of-performance-ration/>, consulted 01/15/2017.
- [15]. <https://motorhomeadvantage.com/wp-content/uploads/2017/09/non-Grid-System.jpg>
- [16]. <https://sam.nrel.gov/> consulted 17/01/2018
- [17]. <https://solar-energy.technology/definitions/photovoltaic-effect.html> accessed 17/01/2018
- [18]. <https://solargis.com/products/maps-and-gis-data/free/download/niger> accessed 18/01/2018
- [19]. <https://www.altestore.com/howto/electrical-characteristics-of-solar-panel> consulted 01/15/2017.
- [20]. <https://www.altestore.com/howto/introduction-to-solar-electricity-a89/> consulted 01/15/2017.
- [21]. [https://www.e-education.psu.edu/astro801/content/13\\_p4.html](https://www.e-education.psu.edu/astro801/content/13_p4.html) accessed on 20/12/2017
- [22]. <https://www.electrical4u.com/solar-cell/> accessed on 20/03/2017
- [23]. <https://www.google.com/url?sa=i&rct=j&q=&esrc=s&source=images&cd=&cad=rja&uact=8&ved=0ahUKEwjTnJbLrtDYAhXHyRQKHT80C2gQjRwIBw&url=https%3A%2F%2F>

- [www.e-education.psu.edu/%2Feme810/%2Fnode/%2F469&psig=AOvVaw1NXkhGF\\_DHVtidoeOsS6pi&ust=1515775655264189](http://www.e-education.psu.edu/%2Feme810/%2Fnode/%2F469&psig=AOvVaw1NXkhGF_DHVtidoeOsS6pi&ust=1515775655264189) accessed on 10/01/2018
- [24]. [https://www.google.com/url?sa=t&rct=j&q=&esrc=s&source=web&cd=6&cad=rja&uact=8&ved=0ahUKEwjYkNenpuTYAhXKvRQKHQqkAyAQFghXMAU&url=http%3A%2F%2Fwww.labri.fr%2Fperso%2Fbillaud%2FHelios2%2Fresources%2Fen06%2FChapter\\_6\\_UB\\_zimmer.pdf&usg=AOvVaw3KrFYwSqfNko8iGSoM2PUr](https://www.google.com/url?sa=t&rct=j&q=&esrc=s&source=web&cd=6&cad=rja&uact=8&ved=0ahUKEwjYkNenpuTYAhXKvRQKHQqkAyAQFghXMAU&url=http%3A%2F%2Fwww.labri.fr%2Fperso%2Fbillaud%2FHelios2%2Fresources%2Fen06%2FChapter_6_UB_zimmer.pdf&usg=AOvVaw3KrFYwSqfNko8iGSoM2PUr) accessed on 12/01/2018
- [25]. <https://www.linkedin.com/pulse/7-most-popular-solar-pv-design-simulation-software-eslam-allam> accessed on 20/11/2017
- [26]. <https://www.ncbi.nlm.nih.gov/pmc/articles/PMC3899746/>, consulted 01/15/2017.
- [27]. <https://www.nrcan.gc.ca/energy/software-tools/7465> consulted 17/01/2018
- [28]. <https://www.reep.org/niger-2012>, 2012. Consulted 01/12/2017.
- [29]. <https://www.youtube.com/watch?v=ab6jV4VBWZE>, watch on 12/26/2016
- [30]. [Modeling Solar Radiation at the Earth's Surface](#) accessed on 20/01/2017

## APPENDIX



### Appendix A: Datalogger Connection Scheme

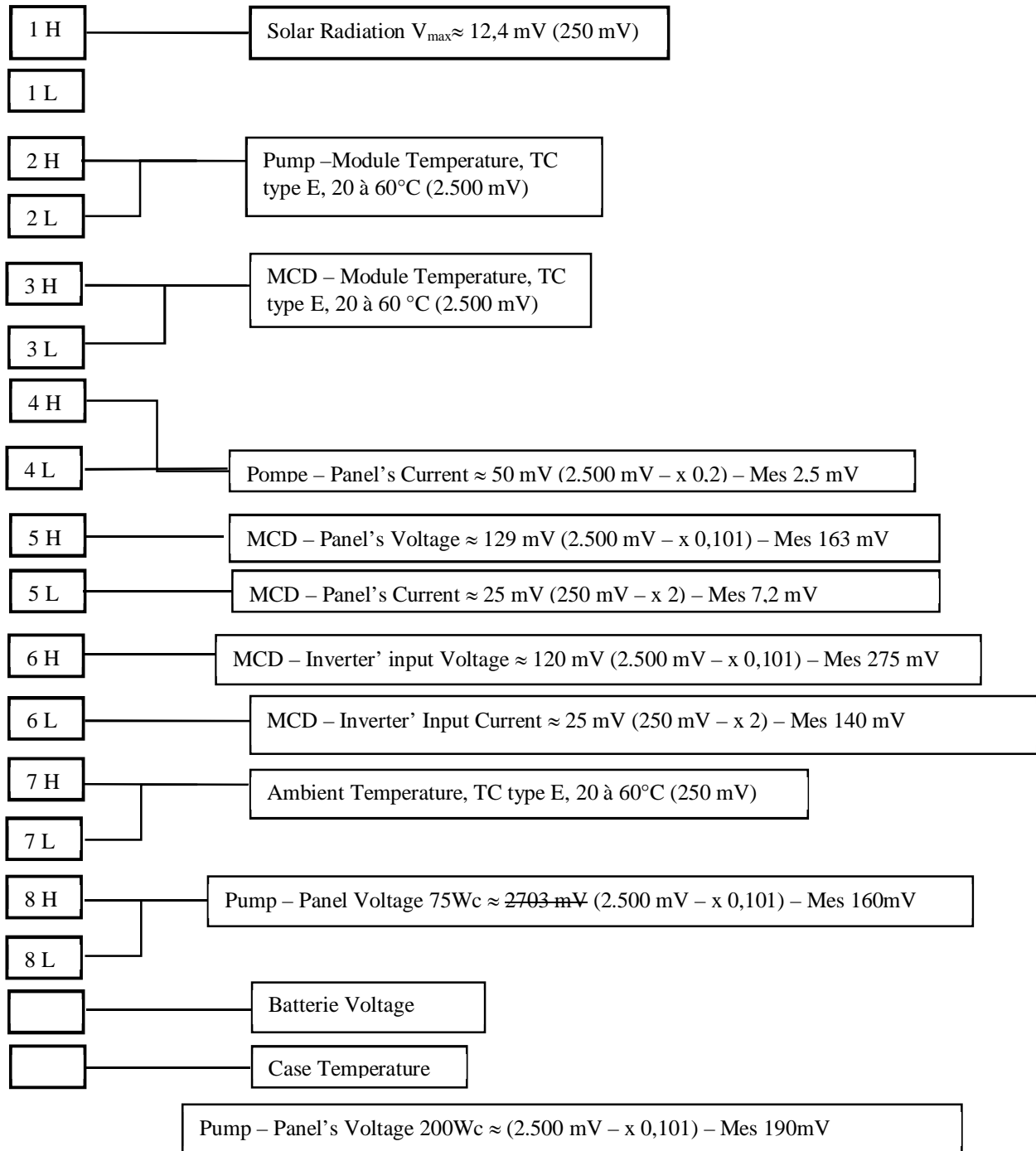

## Appendix B: Datalogger Running Program

```

Const range1=mV250
Const integp=250
Public Ptemp,batt_volt,GI,Tm(2),Ta
Public Imod1,Imod2,Umod1,Umod2,Ieond,Isond,Ueond,Mult(8),offset(8)
Units Ptemp=degC
Units Tm(2)=degC
Units Ta=degC
Units GI=mvolt
Units Imod1=mvolt
Units Imod2=mvolt
Units Umod1=mvolt
Units Umod2=mvolt
Units Ieond=mvolt
Units Isond=mvolt
Units Ueond=mvolt
DataTable(Sarandou,1,100000)
  DataInterval (0,5,min,10)
    Average(1,GI,FP2,0)
    Average(1,batt_volt,FP2,0)
    Average(2,Tm(),FP2,0)
    Average(1,Ta,FP2,0)
    Average (1,Imod1,FP2,0)
    Average (1,Imod2,FP2,0)
    Average (1,Umod1,FP2,0)
    Average (1,Umod2,FP2,0)
    Average (1,Ieond,FP2,0)
    Average (1,Isond,FP2,0)
    Average (1,Ueond,FP2,0)
    Average (1,Ptemp,FP2,0)
  EndTable
BeginProg
  Mult(1)=80.64: offset(1)=0 ..... Solar Radiation
  Mult(2)=0.05:offset(2)=0
  Mult(3)=1.001:offset(3)=0 ..... Umod1 (Pump)
  Mult(4)=0.2:offset(4)=0 ..... Imod1 (Pump)
  Mult(5)=0.101:offset(5)=0
  Mult(6)=2:offset(6)=0
  Mult(7)=0.101:offset(7)=0
  Mult(8)=2:offset(8)=0
Scan (1,Sec,0,0)

```

```

PanelTemp (Ptemp,250)
Battery (batt_volt)
VoltSe(GI,1,range1,1,False,0,integp,Mult(1),offset(1))
TCDiff(Tm(),2,mV250,2,TypeE,Ptemp,False,0,250,1,0) ..... 2 temps
VoltSE(Umod1,1,mV2500,7,False,0,integp,Mult(3),offset(3)) ... Module pompe
VoltSE(Imod1,1,mV2500,8,False,0,integp,Mult(4),offset(4)) ... Courant pompe
VoltSE(Umod2,1,mV2500,9,False,0,integp,Mult(5),offset(5))
VoltSE(Imod2,1,mV2500,10,False,0,integp,Mult(6),offset(6))
VoltSE(Ueond,1,mV2500,11,False,0,integp,Mult(7),offset(7))
VoltSE(Ieond,1,mV2500,12,False,0,integp,Mult(8),offset(8))
TCDiff(Ta,1,mV250,7,TypeE,Ptemp,False,0,250,1,0)
VoltDiff(Isond,1,mV2500,8,0,0,integp,Mult(2),offset(2))
CallTable Sarandou
NextScan
EndProg

```

## Appendix C: Technical Characteristics of Isòfoton Batteries

Website <http://ecuador-solar.net/EqBateriaIsòfoton02E.html>

### SPECIFICATIONS:

Applicable to equipment that requires energy support for long periods of time. Internal components built with Pb - Ca alloys, supplying:

- Less resistance to the passage of current
- Greater resistance to overload
- Better performance in load acceptance
- Longer storage time.
  - ✓ Tubular plate design - reinforced, facilitating energy delivery and reducing gasification
  - ✓ Thick plates to store a large amount of energy and low corrosion to the destruction of its components
  - ✓ Low concentration of sulfuric acid, which protects the internal components from corrosion
  - ✓ Envelope separators with high mechanical resistance for greater safety and prevention of accumulator faults.

### TECHNICAL SPECIFICATIONS:

Maintenance:	Free maintenance
Lifespan:	8-10 years for PV applications.
Plates:	Tubular with alloys Pb – Ca
Gas recombination:	Yes (greater than 95%)
Container material:	ABS, impact resistant
Separator material:	Microporous and corrugated
Electrolyte:	gelled sulfuric acid
Safety valve:	Yes
Terminals:	Antifugas, reinforced by copper or brass
Standards:	ISO9001, DIN40742, IEC896-2

## Appendix D: *Household's Inquiry*

ENERGY USER	Responses/Options								Notes (surveyor)	
I. Background information										
I.1.Date of survey										
I.2.Interviewee code										
I.3.Garden code										
I.4.Village code										
I.5.Gender	Male				Female					
I.6.Size of household										
I.7.To what group of age do you belong?	<u>1.</u> 18–25	<u>2.</u> 26–32	<u>3.</u> 33–39	<u>4.</u> 40–46	<u>5.</u> 47–53	<u>6.</u> 54–60	<u>7.</u> 61+	<u>8.</u> Prefer not to say		
I.8.Position in the household	Head			Member			Other(Specify)			
I.9.Type of habitat									Observation	
I.10.Level of education	<u>1.</u> Primary school	<u>2.</u> High school	<u>3.</u> University degree	<u>4.</u> Koranic education	<u>5.</u> Tertiary education	<u>6.</u> Illiterate				
I.11.Income Category (mean daily in F CFA)	100	≤500	500-1000	1000-2000	2000-5000	≥5000				
I.12.Primary source of support for the household?	<u>1.</u> Farming	<u>2.</u> Breeding	<u>3.</u> Fishing	<u>4.</u> Business	<u>5.</u> Handicraft	<u>6.</u> Salaried	<u>7.</u> Housekeeper	<u>8.</u> Others		
I.13.What are secondary occupations in the household?	<u>1.</u> Farming	<u>2.</u> Breeding	<u>3.</u> Fishing	<u>4.</u> Business	<u>5.</u> Handicraft	<u>6.</u> Salaried	<u>7.</u> Housekeeper	<u>8.</u> Others		
I.14.What are sources of cash income for the interviewee?	<u>1.</u> Farming	<u>2.</u> Breeding	<u>3.</u> Fishing	<u>4.</u> Business	<u>5.</u> Handicraft	<u>6.</u> Salaried	<u>7.</u> Housekeeper	<u>8.</u> Others		

<b>I.15.</b> What are sources of cash income for other household members?	Farming	Breeding	Fishing	Business	Handicraft	Salaried	Housekeeper	Others	
<b>II. Social-Economic aspects of energy use</b>									
<b>II.1.</b> Do use electricity for your activity?	Yes				No				
<b>II.2.</b> Since when did you begin to use this electricity?									
<b>II.3.</b> What is(are) the source(s) of the electricity used in your activity?	NIGELEC	Solar panels	Diesel Generator	Biofuel	Kerosene	Others			
<b>II.4.</b> How often do you use these sources of electricity?	NIGELEC	Solar panels	Diesel Generator	Biofuel		Kerosene	Others		
<b>II.5.</b> What do you use this electricity for?	Cooking	Lighting	Drinking water supply	Irrigation	Heating water	Education	Business	Others	
<b>II.6.</b> Why do you use this(these) particular source(s) of electricity in your activity?	Saving money	Saving time	Comfort	Increasing income	Rising yield	Protecting environment	Scholar enrollment	Increasing success rate	Others
<b>II.7.</b> How much did you pay to purchase and install this(these) source(s) of energy?									
<b>II.8.</b> How did you finance the purchase and installation? (Where did the money come from?)									

<b>II.9.</b> What expenses have you incurred after the installation?	Routine maintenance		Fuel supply		Purchase of spare materials		Others (Comment)				
<b>II.10.</b> Do you earn any money because you have installed this source of electricity, or has it helped you increase your income?	Yes, how so?				No, why?						
<b>II.11.</b> What other sources of electricity have you used before in your activity/household?	NIGEELEC	Solar panels		Diesel Generator		Biofuel	Kerosene		Others		
<b>II.12.</b> What differences do you see between these electricity sources?	Saving money	Saving time	Comfort	Increasing income	Rising yield	Protecting environment		Scholar enrollment	Increasing success rate	Others	
<b>II.13.</b> How has having this electricity source changed your life?											
<b>II.14.</b> What are technologies using source of solar energy do you encounter in the village?											
<b>II.15.</b> How do you think this source of solar energy has changed people's lives around you?											
<b>II.16.</b> How has this source of solar energy changed your life?	Saving money	Saving time		Comfort		Increasing income		Rising yield	Increasing success rate		
	Death rates	Protecting		Scholar		Drugs		Better	Others		



	reduction	environment	enrollment	availability	healthcare	(comment)	
<b>II.17.</b> Which energy source are you used to supply in water?	NIGELEC	Solar panels	Diesel Generator	Biofuel	Kerosene	Others	
<b>II.18.</b> How often do you use these sources of energy?	NIGELEC	Solar panels	Diesel Generator	Biofuel	Kerosene	Others	
<b>II.19.</b> Do you pay to get water?	Yes			No (skip to <b>II.21.</b> )			
<b>II.20.</b> If yes, why?	Fuel supply	Routine maintenance	Return of investment	To buy spare materiel		Others(Comment)	
<b>II.21.</b> How much are you paying per day?							
<b>II.22.</b> If no, why?	Subsidies		Cooperative		Insurance	Others(Comment)	
<b>II.23.</b> If the village is supplied in water by solar panels do you know why this choice?	Saving time		Saving money	Comfort	Cheapness	Environmentally friendly	Others
<b>II.24.</b> If one day the water pump stops operating, how will people feel?	Much better	Somewhat better	Stayed the same	Somewhat worse		Much worse	Don't know
<b>II.25.</b> If you have the choice will you invest in solar energy?	Yes, why?			No, why?			
<b>III. Environmental aspects</b>							
<b>III.1.</b> Have you noticed any impacts on the environment with any sources of electricity you use now, or have used in the past?	Yes			No			

<b>III.2.</b> If yes, which are these impacts?					
<b>III.3.</b> How do you feel the sources of energy you have installed now impact the environment?					
<b>IV. Migration</b>					
<b>IV.1.</b> Has anyone in the neighboring left because it did not have reliable sources of electricity?	Yes		No		
<b>IV.2.</b> Has installing new sources of electricity had impacted the migration of neighboring members?	Yes		No		
<b>IV.3.</b> Does the use of solar panels impact migration rate?	Yes, how?		No, why?		
	Increase	Decrease	Don't know	No change	
<b>IV.4.</b> If yes, how many people in your household/neighboring migrate from (or to) the village each year?					
<b>IV.5.</b> Out of 10 households, how many people do you think migrate from (or to) the village?					
<b>IV.6.</b> Has the frequency of emigration changed since the advent of solar panels in the village?	Never happened	No change	Decrease	Increase	

## Appendix E: *Commercial Inquiry*

MICRO-ENERGY ENTREPRENEURSHIP, INVESTORS	Responses/Options							Notes (survey or)		
<b>I. Background informations</b>										
<b>I.1.</b> Date of survey										
<b>I.2.</b> Location code										
<b>I.3.</b> Meeting place										
<b>I.4.</b> Type of group (micro-energy entrepreneurship, investors)										
<b>I.5.</b> Gender	<b>Male:</b>			<b>Female:</b>						
<b>I.6.</b> Person interviewee	Owner			Employee		Relative (son, wife...)				
<b>I.7.</b> Phone number										
<b>I.8.</b> To what group of age do you belong?	<u>1.</u> 18–25	<u>2.</u> 26–32	<u>3.</u> 33–39	<u>4.</u> 40–46	<u>5.</u> 47–53	<u>6.</u> 54–60	<u>7.</u> 61+	<u>8.</u> Prefer not to say		
<b>I.9.</b> Level of education	1.Primary school	2.High school	3.University degree	4.Koranic education	5.Tertiary education	6.Illiterate				
<b>I.10.</b> Main source of income										
<b>II. Energy investment</b>										
<b>II.1.</b> Since when did you begin this activity?										
<b>II.2.</b> How much did you pay to purchase and install this source of electricity?	1.Purchase			2.Installation		3.Both				
<b>II.3.</b> Where did the money come from?	1.Purchase			2.Installation		3.Both				
	1.Credit	2.Sell of livestock	3.Others	1.Credit	2.Sell of livestock	3.Others	1.Credit	2.Sell of livestock	3.Others	
<b>II.4.</b> Do you pay for maintenance?	Yes, how much?				No, why?					

<b>II.5.</b> Why the choice of solar panels as source of electricity?					
<b>II.6.</b> Do you share your electricity with anyone outside your household?	Yes		No		
<b>II.7.</b> If yes, how much do they pay? (For all users)	1.Daily	2.Weekly	3.Monthly	4.Yearly	Sum of all users
<b>II.8.</b> For which type of activities your electricity is used for?	1.Phones charge		2.Home use	3.Others	
<b>II.9.</b> Since when did you begin to sell this electricity?					
<b>II.10.</b> For how long the system is running during a day?					
<b>II.11.</b> How do you find the turnout of your customers when purchasing and/or installing solar energy technology?	1.Excellent	2.Average	3.Fair	4.None	
<b>II.12.</b> How long do you expect the return on investment?					
<b>II.13.</b> How much is your turnover?					
<b>II.14.</b> Will you agree and recommended to other people to invest in solar panels?	Yes, why?		No, why?		

<b>II.15.</b> Did your technology change people live? Why?	Yes	No	
<b>II.16.</b> According to the environment where you have installed solar panels, is this technology sustainable and economic? Why?			
<b>II.17.</b> What are the major complaints beneficiaries' customers have?			

### Appendix F: Income Category According to the Source of Income

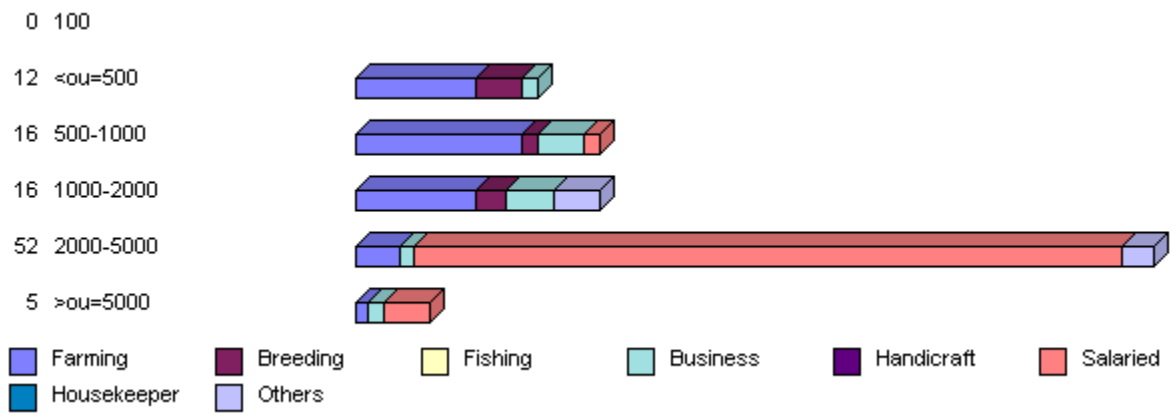

## Appendix G: Some Experimental Data

### ❖ Current-Voltage manually measurement

Time ( $\Delta t=10\text{min}$ )	Voltage Panel 1		Voltage Panel 2		Current	
	(mV)	(V)	(mV)	(V)	(mV)	(A)
Coefficient		0,101		0,101		0,2
10:20 AM	155	15,7	196	19,8	9,2	1,8
10:30 AM	160	16,2	194	19,6	9,9	2,0
10:40 AM	151	15,3	191	19,3	10,5	2,1
10:50 AM	151	15,3	190	19,2	11,2	2,2
11:00 AM	149	15,0	190	19,2	11,5	2,3
11:10 AM	147	14,8	189	19,1	12,2	2,4
11:25 AM	144	14,5	188	19,0	12,8	2,6
11:30 AM	143	14,4	187	18,9	13,0	2,6
11:50 AM	140	14,1	186	18,8	13,8	2,8
12:00 PM	139	14,0	185	18,7	14,2	2,8
12:10 PM	139	14,0	185	18,7	14,7	2,9
12:20 PM	137	13,8	184	18,6	14,9	3,0
12:30 PM	137	13,8	184	18,6	15,4	3,1
12:40 PM	136	13,7	183	18,5	15,3	3,1
12:50 PM	136	13,7	182	18,4	15,5	3,1
1:00 PM	135	13,6	182	18,4	15,4	3,1
1:10 PM	134	13,5	181	18,3	15,5	3,1
1:20 PM	134	13,5	180	18,2	15,5	3,1
1:30 PM	135	13,6	182	18,4	15,6	3,1



❖ *Solar Radiation Measurements*

<b>Date</b>	<b>Time</b>	<b>Solar Radiation(W/m<sup>2</sup>)</b>	<b>Power (kW)</b>
16/12/2017	10:20 AM	646	6,30
16/12/2017	10:30 AM	760	7,42
16/12/2017	10:40 AM	667	6,50
16/12/2017	10:50 AM	681	6,64
16/12/2017	11:00 AM	698	6,81
16/12/2017	11:10 AM	711	6,94
16/12/2017	11:25 AM	745	7,27
16/12/2017	11:30 AM	756	7,37
16/12/2017	11:50 AM	789	7,69
16/12/2017	12:00 PM	799	7,79
16/12/2017	12:10 PM	816	7,96
16/12/2017	12:20 PM	829	8,08
16/12/2017	12:30 PM	838	8,17
16/12/2017	12:40 PM	851	8,30
16/12/2017	12:50 PM	852	8,31
16/12/2017	1:00 PM	844	8,23
16/12/2017	1:10 PM	839	8,18
16/12/2017	1:20 PM	848	8,27
16/12/2017	1:30 PM	846	8,25